

编号/Number	4402-03163	版本/Version	001
名称/Name	MY Series (10kVA-40kVA) UPS User Manual	备注/Remark	英文

手册印刷要求

印刷尺寸: 32K(210mm×140mm) 16K(210mm×285mm) 8K(420mm×285mm)
130mm*150mm 其他:_____

纸 质: 封面: 157g / m² 铜版纸, 内页: 100g / m² 双胶纸
105g / m² 哑粉纸双面印刷
封面: 128g / m² 哑粉纸, 内页: 100g / m² 双胶纸
其他:_____

包装方式: 参照《WI02-ET-266 纸质类随机文件加工技术规范》 其他:_____

印刷颜色: 黑白 四色 其他:_____

特殊工艺: 无 其他:_____

其他要求: 无 其他:_____

注: 此页为手册加工说明, 不属于手册内容。

升级说明: First issue.

拟制/日期 Prepared By/Date	审核/日期 Checked By/Date	核准/日期 Approved By/Date
陈毓婷		



MY Series (10kVA-40kVA) UPS

User Manual

Copyright © KehuaHengshengCo.,Ltd.2020.All rights reserved.

No part of this document may be reproduced or transmitted in any form or by any means without prior written consent of KehuaHengshengCo.,Ltd.

Trademarks and Permissions



and other Kehua trademarks are trademarks of KehuaHengsheng Co., Ltd.

All other trademarks and trade names mentioned in this document are the property of their respective holders.

Notice

The purchased products, services and features are stipulated by the contract made between Kehua and the customer. All or part of the products, services and features described in this document may not be within the purchase scope or the usage scope. Unless otherwise specification in the contract, all statements, information, and recommendations in this document are provided "AS IS" without warranties, guarantees or representations of any kind, either express or implied.

The information in this document is subject to change without notice. Every effort has been made in the preparation of this document to ensure accuracy of the contents, but all statements, information, and recommendations in this document do not constitute a warranty of any kind, express or implied.

KEHUA HENGSHENG CO.,LTD.

Address:	No.457,MalongRoad,TorchHigh-TechIndustrialZone,Xiamen,Fujian,China
Manufacturer:	ZHANGZHOU KEHUA TECHNOLOGYCO.,LTD.
Postal Code:	361000(XIAMEN), 363000(ZHANGZHOU)
Website:	www.kehua.com
E-mail:	service@kehua.com
The Customer Service Telephone:	400-808-9986
Tel:	0592-5160516
Fax:	0592-5162166

Foreword

Summaries

Thank you for choosing the Uninterruptible Power System (hereinafter referred to as the "UPS") product!

This document gives a description of the MY series UPS, including the features, performance, appearance, structure, working principles, installation, operation and maintenance.etc.

Please save the manual after reading, in order to consult in the future.



NOTE



The figures in this manual are just for reference, for details please see the actual product.





Suitable Model

- MY10/MY10S/MY10T
- MY15/MY15S/MY15T
- MY20/MY20S/MY20T
- MY30/MY30S/MY30T
- MY40/MY40S/MY40T

Symbol Conventions

The manual quotes the safety symbols, these symbols used to prompt users to comply with safety matters during installation, operation and maintenance. Safety symbol meaning as follows.

Symbol	Description
 DANGER	Alerts you to a high risk hazard that could, if not avoided, result in serious injury or death.
 WARNING	Alerts you to a medium or low risk hazard that could, if not avoided, result in moderate or minor injury.

Symbol	Description
 CAUTION	Alerts you to a potentially hazardous situation that could, if not avoided, result in equipment damage, data loss, performance deterioration, or unanticipated results.
	Anti-static prompting.
	Be care electric shock prompting.
 TIP	Provides a tip that may help you solve a problem or save time.
 NOTE	Provides additional information to emphasize or supplement important points in the main text.

Product standard: Q/ZZKJ 001

Change History

Changes between document issues are cumulative. The latest document issue contains all the changes made in earlier issues.

Issue 001 (2020-07-10)

First issue.

Contents

1 Safety Description.....	1
1.1 Safety Announcements	1
1.1.1 Safety Instructions	1
1.1.2 Use Announcements for Battery	2
1.1.3 Anti-Static Protection	3
1.2 Operation and Maintenance Requirements	3
1.3 Environment Requirements	3
2 Overview.....	5
2.1 Product Intro.....	5
2.1.1 Model Meaning	5
2.1.2 Features	6
2.1.3 Appearance.....	7
2.1.4 Communication	13
2.1.5 Fittings Illustration.....	20
2.2 Work Principle.....	21
2.2.1 Work Principle Diagram.....	21
2.2.2 Work Mode	22
3 Installation.....	26
3.1 Announcements	26
3.2 Installation Preparation	26
3.2.1 Tools.....	26
3.2.2 Install Environment.....	27
3.2.3 Install Space	27
3.2.4 Select Breaker & Wires	27

3.2.5 Select Input Breaker.....	28
3.2.6 Select Wires	30
3.3 Transport and Unpacking	33
3.3.1 Transport	33
3.3.2 Unpacking	34
3.4 Mechanical Installation	35
3.5 Electrical Connection	38
3.5.1 UPS Wiring Operation	39
3.5.2 Wiring Between UPS and External Battery	47
3.5.3 Wiring of Parallel System	50
4 LCD Screen Operation	55
4.1 Menu Hierarchy	55
4.2 Main Page	56
4.3 System Working Status Display	56
4.4 Monitoring Page	58
4.5 Setting Management.....	58
4.5.1 Parameter Setting	59
4.5.2 Function Setting	60
4.5.3 Log Management	62
4.5.4 Screen Setting	62
4.5.5 Permission Setting	63
5 Touch Screen Operation	65
5.1 Menu Hierarchy	65
5.2 Main Page	67
5.2.1 Icon Meaning	67
5.2.2 Working Status	68
5.2.3 Bypass Information Page	70
5.2.4 Mains Informaiton Page.....	71
5.2.5 Battery Information Page	71
5.2.6 Output Information Page.....	72

5.3 Login Page	73
5.4 Information Management Page	73
5.4.1 Run Information Page	74
5.4.2 History Record Page	76
5.4.3 User Log Page.....	76
5.4.4 Device Infomation Page.....	77
5.5 Setting Management Page	78
5.5.1 System Manage Page	78
5.5.2 Battery Management Page	81
5.5.3 Battery Test Page	84
5.5.4 Dry Contact Page (Reserved).....	85
5.5.5 Communicaiton Setting Page.....	87
5.5.6 HMI Setting Page.....	88
5.5.7 Password Setting Page	88
5.5.8 Device Configuration Page	89
5.5.9 Dedust Setting Page	92
5.5.10 Record Manage Page	92
5.6 Current Fault Page.....	94
5.7 Buzzer Control	95
5.8 ON\OFF Operation.....	96
6 Use and Operation	97
6.1 Check Before Startup	97
6.2 Startup Operation	97
6.3 Shutdown Operation.....	98
6.4 Parallel System Operation	98
6.4.1 Start Parallel System	98
6.4.2 Shut Down Parallel System.....	99
6.4.3 Exit Parallel System.....	99
6.4.4 Redundance Function of Parallel System.....	100
6.5 Periodic Preventative Maintenance	100

6.6 Battery Maintenance	100
6.7 Troubleshooting.....	101
6.7.1 Common Fault	101
7 Package, Transportation and Storage.....	106
7.1 Package	106
7.2 Transportation	106
7.3 Storage	106
A Technical Specifications	107
B Acronyms and Abbreviations	111

1 Safety Description

This chapter introduces the safety announcements. Prior to performing any work on the UPS, please read the user manual carefully to avoid human injury and device damage by irregular operations.

1.1 Safety Announcements

This section introduces the safety announcements that must be complied with and pay special attention while installing, using, maintenance and other relative operations.



CAUTION

Before operating, please read the announcements and operation instructions in this section carefully to avoid accident.

The DANGER, WARNING, CAUTION, etc. in the manual are not all the safety announcements that you must abide by, they are just the supplements for the safety announcements during operating.



NOTE

Our company does not undertake the responsibility caused by violating common safety operation requirements or the safety standard of design, manufacture and use.

1.1.1 Safety Instructions



CAUTION

There exists high temperature and high voltage inside the UPS. During using, please strictly comply with all warnings and operation instruments on the UPS and in the user manual.

**CAUTION**

The UPS is class C3 device. If it is used in residential purpose, it may cause wireless interference. User should take actions to avoid the interference.

- No liquid or other objects are allowed to enter the UPS.
- UPS must be well grounded.
- In case of fire, please use dry power fire extinguisher. If using liquid fire extinguisher, it may cause electric shock.

1.1.2 Use Announcements for Battery

**CAUTION**

Please use specified battery. Non-specified battery will damage the UPS.

- Only authorized professional can replace battery. Do not wear conductive objects, such as watches, bracelets and rings during operating. Wear rubber shoes and gloves and use tools with insulated handle.
- Don't put tools or other conductive objects on the battery.
- It is prohibited to short the positive pole and negative pole of the battery or connect them reversely, which is to avoid fire or electric shock.
- Before connecting or disconnecting the battery terminals, disconnect charger first.
- The battery must be with the same type, model and manufacturer.
- Battery should be kept away from fire source or other electrical equipment that may easily cause spark to avoid human injury.
- Don't open or destroy the battery. The electrolyte in the battery includes some dangerous objects, such as strong acid, which will be harmful to skin and eyes. If it is careless to touch the electrolyte, clean it by a lot of water immediately and then check it in the hospital.
- The waste battery should be disposed according to the local regulations.

1.1.3 Anti-Static Protection



CAUTION

The static generated by human bodies may damage the electrostatic-sensitive components on PCB. Before touching the sensitive component, please wear anti-static rings and well connect the other end of the anti-static rings to ground.

1.2 Operation and Maintenance Requirements



CAUTION

Only authorized professionals are allowed to open the UPS chassis, or it may cause electric shock and the caused UPS fault is out of the guarantee range.

- If UPS needs to be moved, rewired or maintained, disconnect all electrical connection, such as AC power, battery power, etc. to isolate power input. Do not do any work on the UPS until it is powered off completely (≥ 10 min). Otherwise, the output may exist electricity, which may cause electric shock.
- When dismantling fan, do not put fingers or tools into the rotating fan to avoid device damage or human injury.

1.3 Environment Requirements



DANGER

Do not put the UPS in the environment where has inflammable, explosive gas or smog, do not do any operation in this environment.

- Do not use the UPS in the place where has direct sunshine, rain or wet.
- The normal work temperature of UPS is $-5^{\circ}\text{C}\sim 40^{\circ}\text{C}$, relative humidity: 0%-95%, with no condensation (recommended work temperature is $20^{\circ}\text{C}\sim 25^{\circ}\text{C}$, humidity is about 50%).

- Put the UPS in the flat floor without vibration and the vertical gradient is less than 5° . Keep good ventilation around the UPS. The clearance between the rear or the side of UPS and adjacent devices or wall should be at least 300mm~500mm. Poor ventilation will rise temperature inside UPS, which will reduce the service life of inner components and even affect the life span of the UPS.
- The UPS must be used below 2000m. If the altitude exceeds 2000m, it needs to decrease the rated power according to IEC62040-3: 2011 to use.

2 Overview

This chapter mainly introduces the UPS's model meaning, features, structure, work principle, etc.

2.1 Product Intro

MY series UPS is whole high frequency, pure online, double-conversion, smart product. The system is perfect power security for file server, enterprise server, center server, micro-computer, concentrator, telecom system, data center and others that require high quality power protection. They are widely used in many key business areas, such as post, finance, network, stock, railway, etc.

2.1.1 Model Meaning

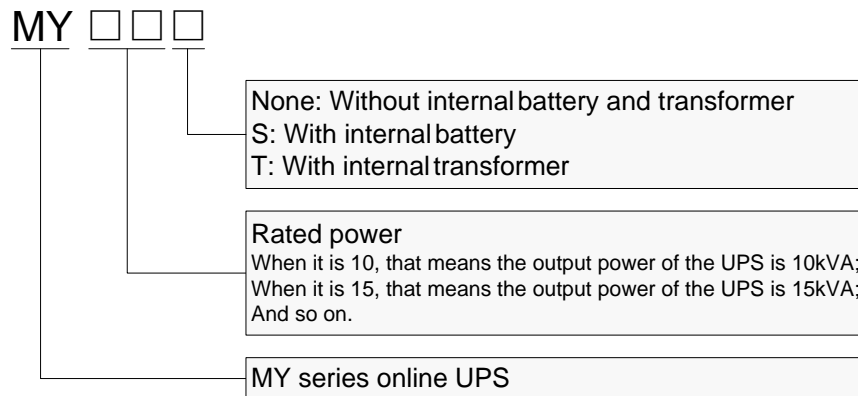

Figure2-1 Model meaning

NOTE

10/10S/10T/15/15S/15T/20/20S/20T can set to three-phase input three-phase output mode, three-phase input single-phase output mode and single-phase input single-phase output mode. 30/30S/30T/40/40S/40T can set to three-phase input three-phase output mode and three-phase input single-phase output mode.

Three-phase input three-phase output (three in three out) is 33 mode UPS, three-phase input single-phase output (three in one out) is 31 mode UPS, single-phase input single-phase output (three in one out) is 31 mode UPS.

User can change the mode of UPS through the wiring, connector jumper of fittings, screen setting and mode connector (just for MY series 30kVA-40kVA) (for more detail please refers to 3.5.1 UPS Wiring Operation).

2.1.2 Features

Completely digitalized smart control

The UPS support various input and output mode, such as 33/31 and 11 (just for MY series 10kVA-20kVA) mode UPS,. The UPS can monitor the grid frequency (50Hz/60Hz) and self-adapt the frequency. The output voltage can be set to 220V/230V/240V, which makes the use more flexible.

Energy conservation and high efficiency

Adopts three-level inverter technology and PFC control technology, the output voltage wave is perfect and the whole efficiency can be 96%, the input power factor is greater than 0.99, which greatly improves the use ratio of electric energy and reduces the load of power grid.

Smart fan speed control

The fan speed is adjusted automatically in accordance with the load status, which prolong fan life and reduce noise.

ECO energy conservation mode design

The UPS is designed with ECO energy conservation mode. When the grid is good, if the UPS operating in this mode, the bypass prior to output, and the efficiency can be 99%.When the bypass voltage or frequency out of normal range and cannot satisfy the user's power supply requirement, it will switch to inverter output, which guarantee the reliability of power supply and also, save energy.

Low mains input voltage

Adopt the independent rapid detection technology. When output load is small, even the battery voltage is 80V, which is the mains low limit, the battery still doesn't discharge. Therefore, in the mains mode, all output power gets from the grid, which is to ensure the battery in 100% energy storage status, and at the same time, reduce the battery discharge times and prolong the service life.

2.1.3 Appearance

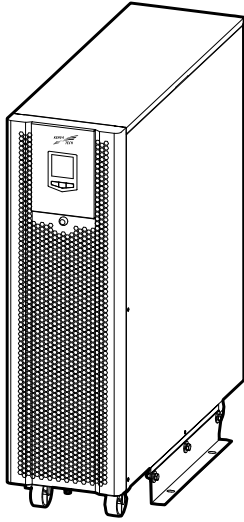

Figure2-2 Appearance of 10/10S/10T/15/15S/15T/20/20S/20T (LCD screen)

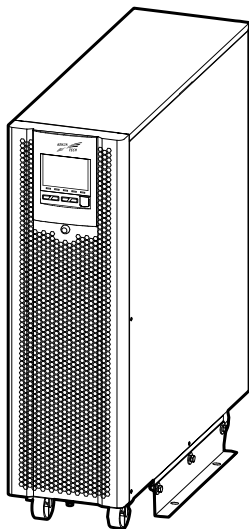

Figure2-3 Appearance of 10/10S/10T/15/15S/15T/20/20S/20T (touch screen, optional)

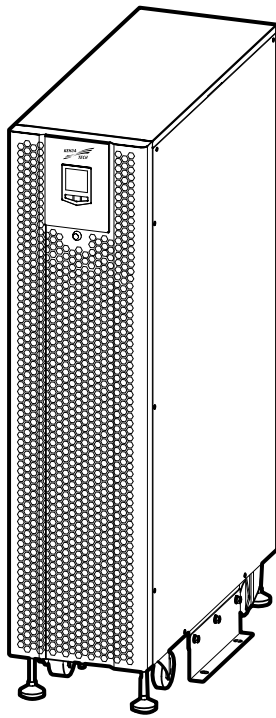

Figure2-4 Appearance of 30/30S/30T/40/40S/40T (LCD screen)

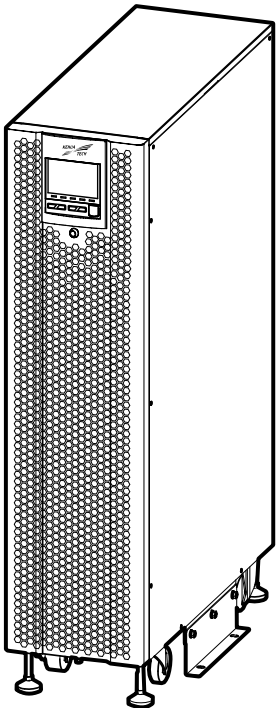

Figure2-5 Appearance of 30/30S/30T/40/40S/40T (touch screen, optional)



NOTE

MY series (10kVA-40kVA) UPS has 2 types of operation panel, LCD screen and touch screen (optional).

Operation panel

- LCD screen

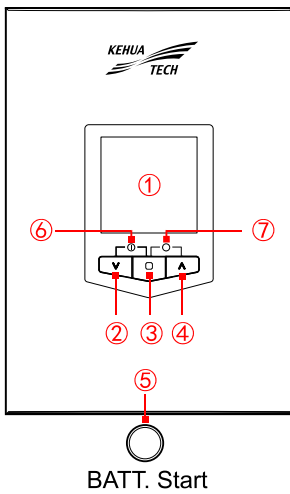

Figure2-6 Operation panel

Table2-1 Illustration for LCD screen operation panel

No.	Name	Illustration
Illustration for operation panel		
①	LCD screen display	Shows the working status and system setting.
②	"▼" page down button and power off LED indicator	Short press "▼" button, the LCD will enter next setting page.
③	"□" function button and breathing light	Short press "□" button to confirm the command of the current LCD page. Long press "□" button for 3s, will entry the parameter and function setting page. When UPS is on, "□" button will be in a cycle of light up to fade out.
④	"▲" page up button and power on LED indicator	Short press "▲" button, the LCD will enter previous page or previous option.
⑤	"BATT. Start" button	Press "BATT. Start" button for 7s, the system will build the aux power.

No.	Name	Illustration
Combination buttons operation instructions		
⑥	Power on	Press the "▼" and "□" button for 2s at the same time, the UPS on and the corresponding indicate LED is on.
⑦	Power off	Press the "□" and "▲" button for 2s at the same time, the UPS off and the corresponding indicate LED is on.

● Touch screen (optional)

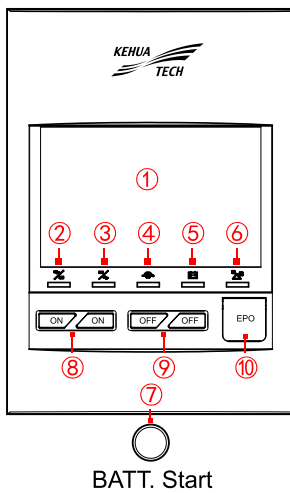

Figure2-7 Operation panel

Table2-2 Illustration for touch screen operation panel

No.	Name	Illustration
Illustration for operation panel		
①	Touch screen display	Shows the working status and system setting.
②	AC/DC indicator	On (green): rectifier works normally; On (red): rectifier abnormal.
③	DC/AC indicator	On (green): inverter works normally; On (red): inverter abnormal.
④	BYP. indicator	On (green): bypass output; On (red): bypass abnormal.

No.	Name	Illustration
⑤	BATT. LOW indicator	On (red): battery is low-voltage.
⑥	OVERLOAD indicator	On (red): output is overload or overload protection.
Buttons operation instructions		
⑦	"BATT. Start" button	Press "BATT. Start" button for 7s, the system will build the aux power.
⑧	"ON" combination button	Press a couple "ON" buttons for 1s at the same time, the system will power on.
⑨	"OFF" combination button	Press a couple "OFF" buttons for 1s at the same time, the system will power off.
⑩	EPO emergency power off button	Press the button, the system will power outage immediately.

Battery start

The battery start operation: press "BATT. Start" and power on combination button (LCD) or "ON" combination button (touch screen) for 7s at the same time to start up the UPS.

NOTE

Battery start only works in this case: the UPS power on through battery power when there is no mains power.

Rear panel

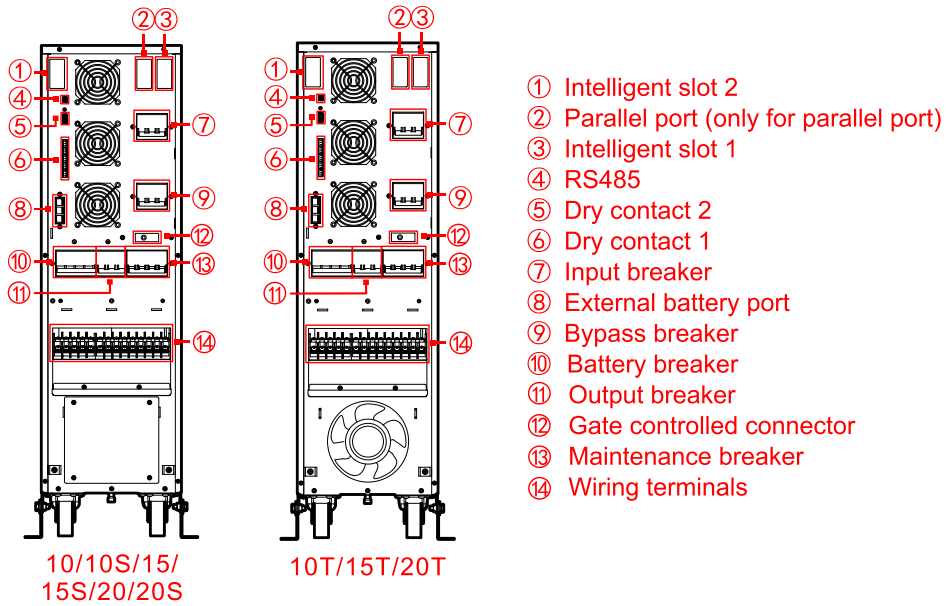

Figure2-8 Structure of 10/15/20kVA rear panel

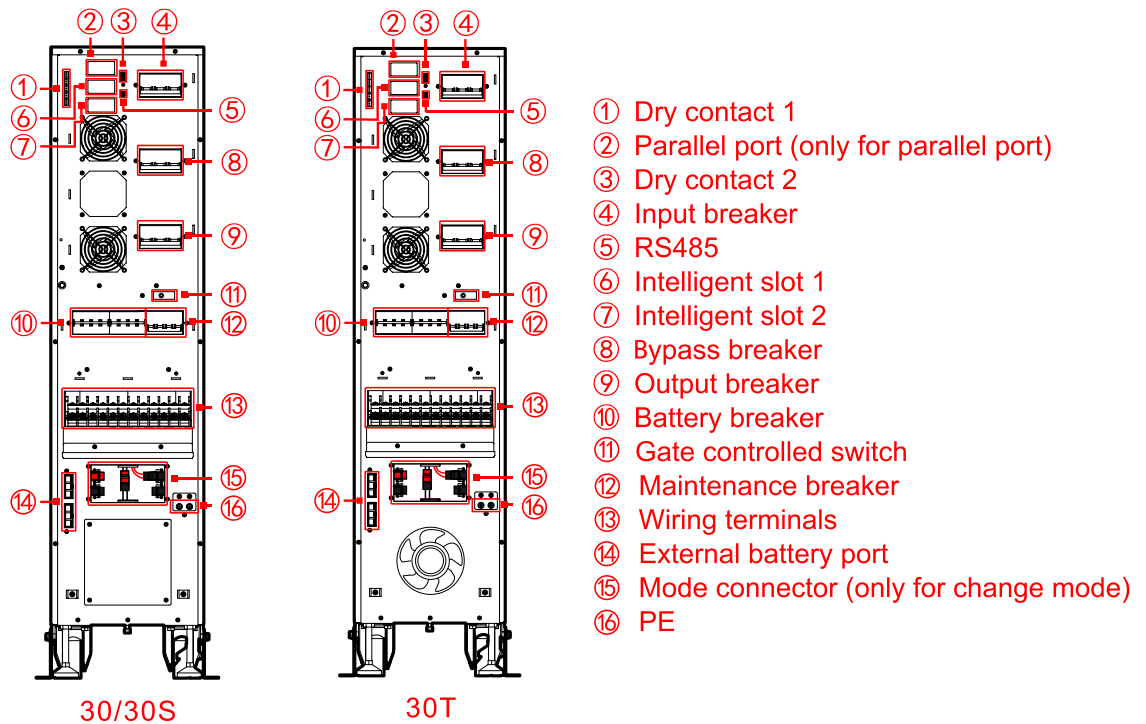

Figure2-9 Structure of 30kVA rear panel

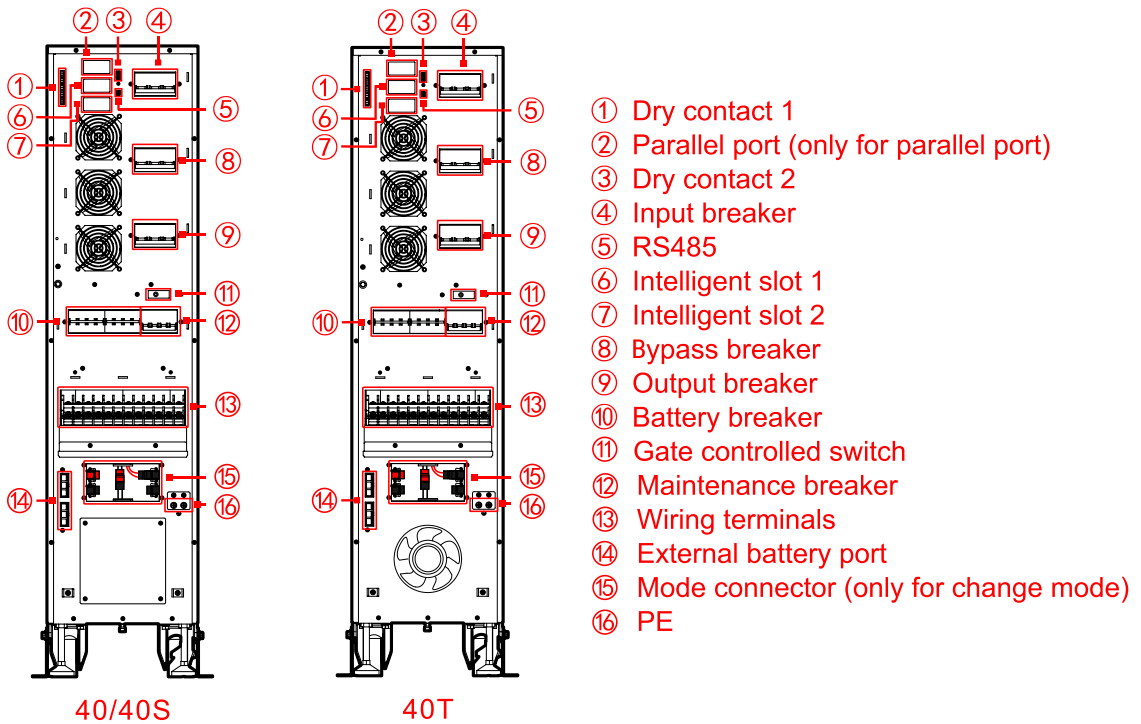

Figure2-10 Structure of 40kVA rear panel

NOTE

The wiring terminal of 33 mode, 31 mode and 11 mode have a little different. For the detail of the wiring terminal of each mode please see 3.5.1 UPS Wiring Operation.



CAUTION

The gate controlled switch release automatically when the maintenance breaker cover is removed and closes automatically when the cover is locked back.

2.1.4 Communication

The supported communication method of this series UPS include RS485, parallel kit, communication dry contact, RS485+relay card, protocol transfer card and SNMP card.

Table2-3 Communication method correspondence with hardware port

Communication way	Communication port
RS485	RS485
Dry contact	Dry contact 1: output dry contact;

Communication way	Communication port
	Dry contact 2: input dry contact (EPO+IN. 1)

Table2-4 Communication method correspondence with hardware port (optional)

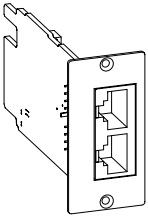
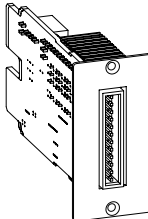
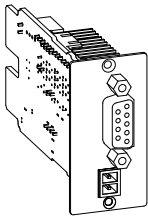
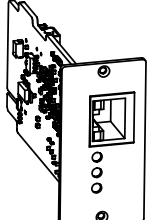
Communication way	Sketch map	Communication port
Parallel kit (optional)		Parallel port
RS485+relay card (optional)		Slot 2 (optional)
Protocol transfer kit (optional)		Slot 1/Slot 2 (optional)
SNMP card (optional)		

RS485

The UPS adopt RS485 series port to communicate with PC. The corresponding pin relationship of RS485 port between UPS and PC is as shown Table2-5.

Table2-5 The corresponding pin relationship of RS485 port between of UPS and PC

RS485 port of UPS	RS485 port of PC
A	A (+)

RS485 port of UPS	RS485 port of PC
B	B (-)

NOTE

The standard RS485 communication ports of rear panel cannot communicate normally when slot 2 is used.

Dry Contact

The control of dry contact signal or transmission of alarm information can be achieved by communication dry contact. Dry contact function can be set through LCD, and can be set and changed through the touch screen.

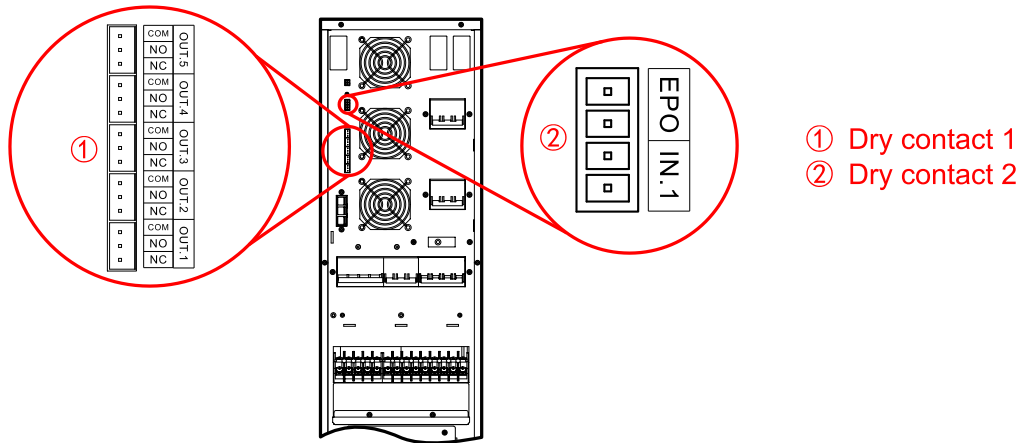

Figure2-11 Dry contact position of 10/10S/10T/15/15S/15T/20/20S/20T

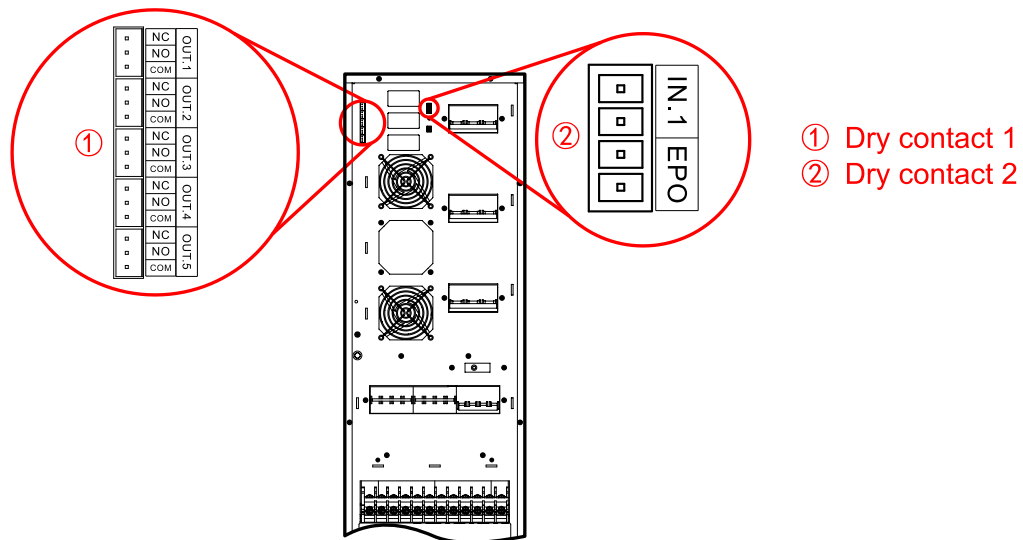

Figure2-12 Dry contact position of 30/30S/30T/40/40S/40T

**NOTE**

The dry contact position of MY series (30kVA-40kVA) is the same, above we take MY30 as an example to illustrate.

**CAUTION**

Relay dry contact capacity is 277Vac/30VDC/10A, relay coil voltage is 12V.

Table2-6 Dry contact functions illustration

No.	Silk-screen		Function illustration	Remarks
Dry contact 1	OUT.1	NC	Trigger action when signal is valid: NO and COM is connect, which disconnect with NC. The signal is settable and refers to the note for detail. Default is mains abnormal.	NC: close normally; NO: open normally; COM: common port.
		NO		
		COM		
	OUT.2	NC	Trigger action when signal is valid: NO and COM is connect, which disconnect with NC. The signal is settable and refers to the note for detail. Default is bypass abnormal.	
		NO		
		COM		
	OUT.3	NC	Trigger action when signal is valid: NO and COM is connect, which disconnect with NC. The signal is settable and refers to the note for detail. Default is battery abnormal.	
		NO		
		COM		
	OUT.4	NC	Trigger action when signal is valid: NO and COM is connect, which disconnect with NC. The signal is settable and refers to the note for detail. Default is output abnormal.	
		NO		
		COM		
	OUT.5	NC	Trigger action when signal is valid: NO and COM is connect, which disconnect with NC. The signal is settable and refers to the note for detail. Default is overload alarm.	
		NO		
		COM		

No.	Silk-screen		Function illustration	Remarks
Dry contact 2	EPO	-	The signal is valid when 2P terminal block disconnect. The signal is EPO and cannot settable.	-
	IN. 1	-	The trigger level of signal is settable (NC/NO) and short circuit is valid for default. The signal is settable and refers to the note for detail. Default is charge forbidden.	-



NOTE

Only touch screen model of the UPS can be set the dry contact setting, the LCD screen model of the UPS cannot be set the dry contact setting which keep default setting.

The settable item and illustrations of the corresponding input and output dry contact are shown in Table2-7 and Table2-8.

Table2-7 The settable item and illustrations of input dry contact

NO.	Item	Illustration
1	Charge forbidden	The charge forbidden signal of battery: The UPS will alarm and turn off the battery charge when receiving this signal. The trigger level of signal is settable.
2	External MBB on	The breaker on signal of external maintenance bypass: The UPS will alarm and turn off the inverter output and switch over bypass output when receiving this signal. The trigger level of signal is settable.
3	External BB status	The breaker disconnected signal of external battery: The UPS will alarm and prompts fault when receiving this signal. The trigger level of signal settable.
4	UPS remote on/off	The remote on/off signal of UPS: The UPS will on when receiving this signal. The trigger level of signal is settable.
5	Batt. ground fault	The fault signal of battery ground: The UPS will report an alarm and prompts fault when receiving this signal. The trigger level of signal is settable.

NO.	Item	Illustration
6	Discharge forbidden	The discharge forbidden signal of battery: The UPS will report an alarm and prohibits the battery discharge when receiving this signal. The trigger level of signal is settable.

Table2-8 The settable item and illustrations of output dry contact

NO.	Item	Illustration
1	Mains abnormal	When mains grid is abnormal, the signal is valid and triggers action of dry contact.
2	Bypass abnormal	When bypass is abnormal, the signal is valid and triggers action of dry contact.
3	Battery abnormal	When battery is abnormal, for example: battery low-voltage, battery over-voltage, battery over-temperature and battery disconnected, the signal is valid and triggers action of dry contact.
4	Output abnormal	When output is abnormal, the signal is valid and triggers action of dry contact.
5	Overload abnormal	When bypass or inverter of UPS is overloaded, the signal is valid triggers action of dry contact.
6	General abnormal	When the UPS is alarming for fault, the signal is valid and triggers action of dry contact.
7	Normal operation	When the UPS is in the normal operation, the signal is valid and triggers action of dry contact.
8	Battery operation	When the UPS is in the battery operation, the signal is valid and triggers action of dry contact.
9	Bypass operation	When the UPS is in the bypass operation, the signal is valid and triggers action of dry contact.
10	UPS on/off status	When the UPS is in on status, the signal is valid and triggers action of dry contact.
11	Battery low	When battery is low voltage, the signal is valid and triggers action of dry contact.

NO.	Item	Illustration
12	ECO mode	When the UPS output mode is ECO, the signal is valid and triggers action of dry contact.
13	Fan fault	When fan is abnormal, the signal is valid and triggers action of dry contact.

Optional Communication

- Parallel port

Parallel kit (optional): Built-in card is suitable for CAN communication between parallel equipments when the UPS is upgraded from single device to parallel device. The parallel function requires parallel kit for the standard UPS model is single equipment. Install the parallel kit in the parallel port after the UPS was power off. After the installation is completed, power up the UPS and set the UPS to parallel mode through the screen display. Please refer to the installation guide of parallel kit for detailed introduction, and refer to the 4.5.2 Function Setting of LCD screen or 5.5.8 Device Configuration Page of touch screen for screen settings.

- Intelligent slot 1/Intelligent slot 2

1. RS485+relay card (optional): Built-in card. Three output dry contacts: mains input abnormal, battery abnormal and inverter status (configurable as bypass output state). Two input dry contacts: battery temperature detection (for charging temperature compensation), battery breaker status detection (configurable as UPS remote on/off detection).
2. Protocol transfer card (optional): Built-in card. One route for RS485 communication, reserved for lithium battery communication (2P green terminal block); the other routes for RS485+RS232. Only one can be selected for communicate (DB9 terminal block).
3. SNMP card (optional): Built-in card and configuration protocol through webpage. Through the web configuration protocol to meet the use of different models or different communication protocols.



NOTE

Please see the installation guide of corresponding optional communication card for more details.

2.1.5 Fittings Illustration

Each device standard with three short circuit wire which the length is 200mm and users can short-circuit the mains input and bypass by it. The installation position is shown in 3.5.1 UPS Wiring Operation.

When the UPS needs an external battery, the optional extension battery wiring assembly can be used to connect the external battery to the equipment. The installation position is shown in 3.5.2 Wiring Between UPS and External Battery.

10/10S/10T/15/15S/15T/20/20S/20T UPS has 2 kinds of optional connector jumper (1# and 2# connector jumper), 30/30S/30T/40/40S/40T UPS has 2 kinds of optional connector jumper (3# and 4# connector jumper), as shown in Table2-9. User can connect the connector jumper to the wiring terminal according need. The installation position of each mode is shown in 3.5.1 UPS Wiring Operation.

Table2-9 Fittings illustration

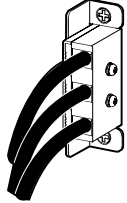
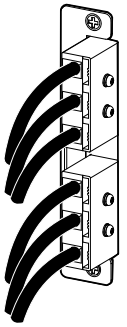
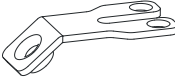
Name	Illustration	Sketch map
Short circuit wire of mains-and-bypass	The length is 200mm	
10~20K extension battery wiring assembly (optional)	1m or 3m of the wiring length for selection (optional)	
30~40K extension battery wiring assembly (optional)	1m or 3m of the wiring length for selection (optional)	
1# connector jumper	2PIN connector jumper (optional)	

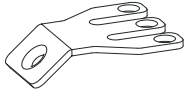
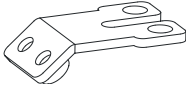
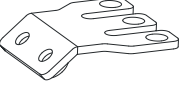
Name	Illustration	Sketch map
2# connector jumper	3PIN connector jumper (optional)	
3# connector jumper	2PIN connector jumper (optional)	
4# connector jumper	3PIN connector jumper (optional)	

2.2 Work Principle

2.2.1 Work Principle Diagram

Work principle diagram of the UPS is as shown in Figure2-13.

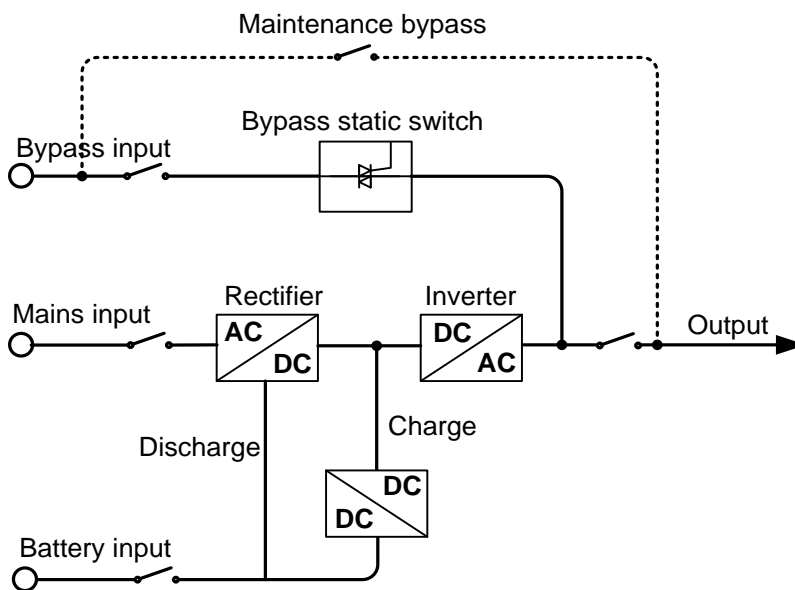

Figure2-13 Work principle diagram

The MY series UPS includes rectifier/PFC, inverter, charger, bypass static switch etc function module, the input power includes mains input, bypass input, battery input, the output mode includes inverter output, bypass output and maintenance bypass output (if equipped).

When mains is normal, the rectifier starts and the charger charges the battery at the same time. When UPS off, if bypass is normal, the system turns to bypass output; when UPS on, the mains boosts by rectifier/PFC and output DC bus voltage, and then go through inverter and output pure sine-wave AC power, the output turns to inverter output to load from bypass output (if equipped).

When mains is abnormal, the battery voltage boosts by rectifier/PFC and output DC bus voltage, and then go through inverter and output pure sine-wave AC power to load. When mains recover normal, the UPS turns to mains mode from battery mode automatically.

2.2.2 Work Mode

There are 5 work modes of the UPS: normal mains power supply mode, battery inverter mode, bypass power supply mode, ECO power supply mode and maintenance bypass power supply mode.

Normal mains power supply mode

When mains power is normal, the UPS works in mains inverter status and charge the battery at the same time. The work mode is as shown in Figure2-14.

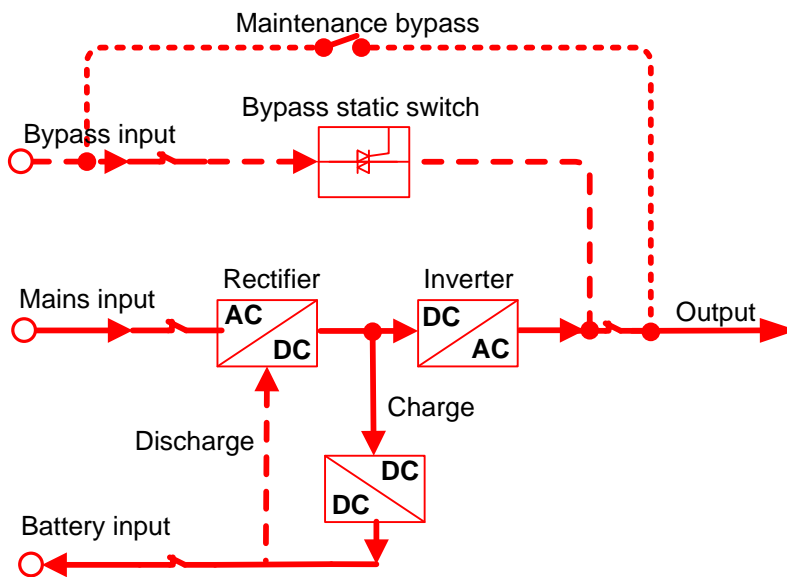

Figure2-14 Normal mains power supply mode (the thick solid line stands for the energy flow direction)

Battery inverter mode

When mains is abnormal, the rectifier will transfer to battery input immediately, boost the battery voltage and then maintain the voltage of DC bus voltage to guarantee the inverter output continuous. As shown in Figure2-15.

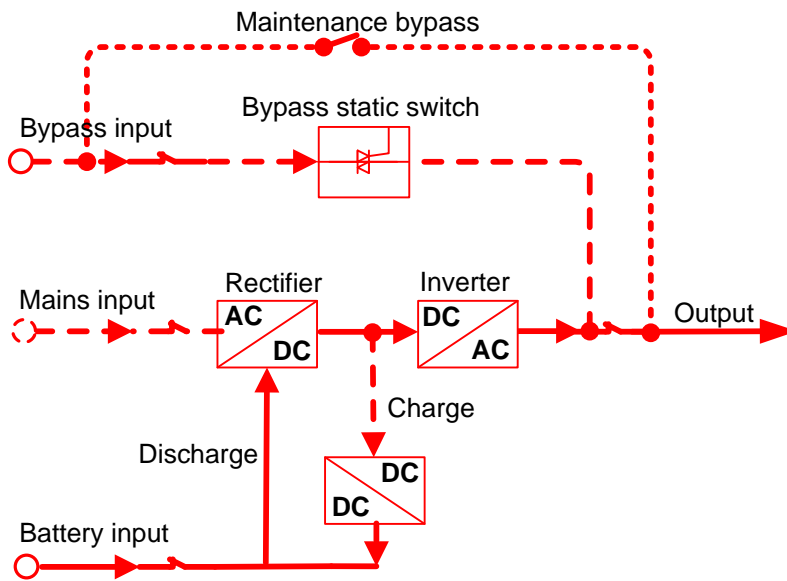

Figure2-15 Battery inverter mode (the thick solid line stands for the energy flow direction)

Before the battery stop discharging, if the mains recover normal, the rectifier will transfer to mains input automatically and charge the battery at the same time. That is to say, the UPS recover normal mains power supply mode. If the mains always abnormal and the battery is running up, the UPS will send sound and light alarm and stop working till battery low-voltage point. At that time, the buzzer long beeps to alarm, the power for load powers down. Under the circumstance of mains power outage completely, the UPS will shut down about 1min later automatically and close the power of the UPS to avoid the battery discharge slimly, thus to protect the service life of battery. Once the mains recover, the UPS will start automatically and turn to normal mains power supply mode.

Bypass power supply mode

Under the circumstance of bypass voltage is normal, when UPS off or fault (such as inverter output overload, over-current surge or IGBT over-temperature etc.) while UPS on, the UPS will output by bypass. When UPS on and the fault removed, it will turn to inverter output again. If the same fault occurs more than 5 times in a short time, the UPS protects and output by bypass until power off manually or power down and remove the fault, restart the UPS and then it will recover normal work.

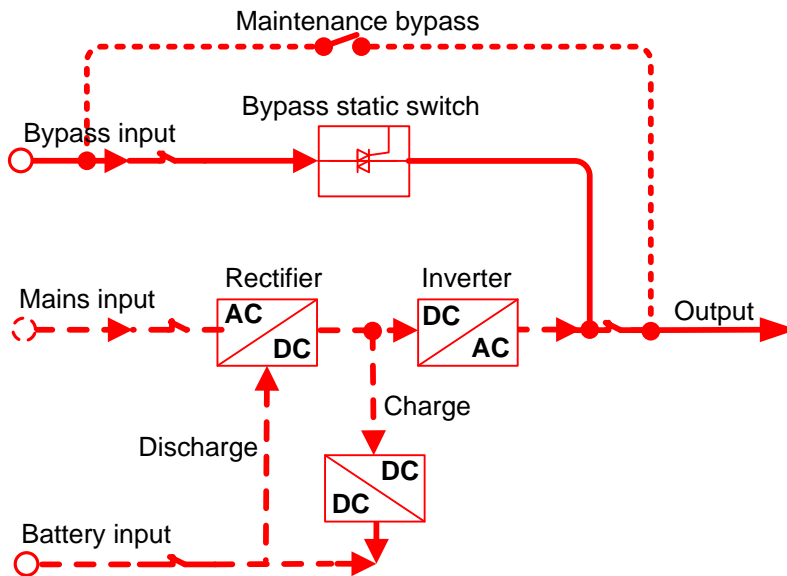

Figure2-16 Bypass power supply mode (the thick solid line stands for the energy flow direction)

ECO power supply mode (just suitable for single UPS)

At the ECO mode, when bypass voltage is normal, the power for load is prior supplied by bypass, when bypass voltage is abnormal, the power for load turns to inverter. ECO mode is an economic operation mode. For the load which does not require high quality, user can select ECO mode to reduce the energy consumption. At the ECO mode, the UPS efficiency can up to 99%.

Maintenance bypass power supply mode

When the UPS needs to be maintained and the power supply for load cannot be interrupted, user can shut down the inverter and make the UPS works in bypass status, the gate controlled switch release automatically when open the maintenance bypass cover, then switch on the maintenance bypass breaker and switch off the mains input breaker and bypass input breaker, output breaker. During the transforming of manual maintenance bypass, AC power is supplied for load by maintenance bypass breaker. At this time, the inner UPS has no electricity, maintainer can perform the maintenance safely.

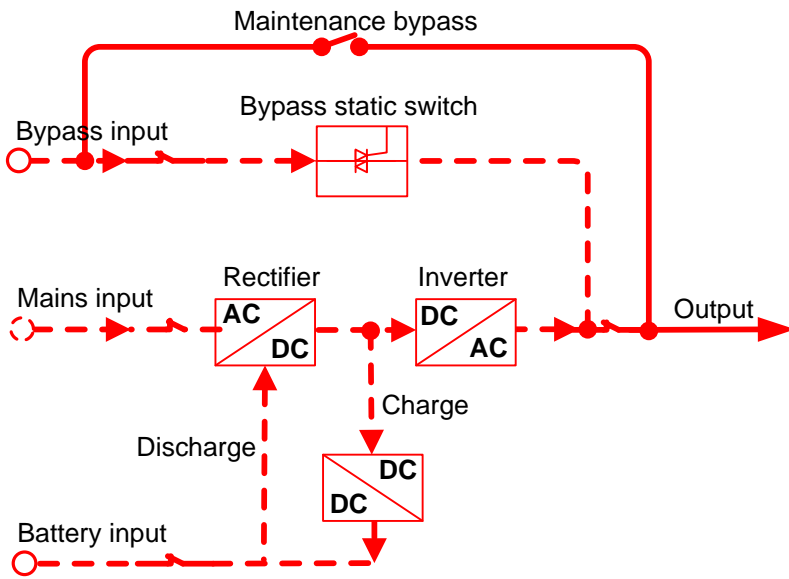

Figure2-17 Maintenance bypass power supply mode (the thick solid line stands for the energy flow direction)

3 Installation







This chapter mainly introduces the installation of the UPS, including unpacking and checking, cable selection, installation, electrical connection, etc.



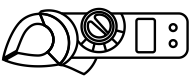

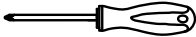

3.1 Announcements

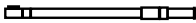
- The installation tools should be with isolated operation, which is to avoid electric shock.
- There exist high-voltage in wiring end, please ensure that the wiring terminal with no electricity, and then the wire connection can be done.
- Place the UPS flat on the ground, avoid tilt and uneven ground.
- Do NOT place goods or sit on the UPS.

3.2 Installation Preparation

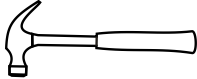
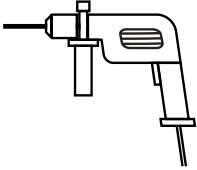
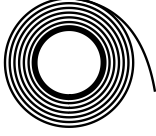
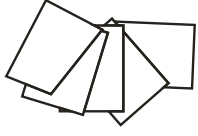
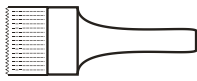
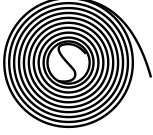
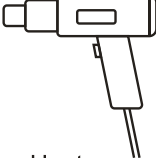
3.2.1 Tools

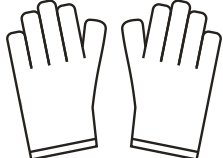
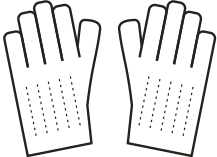
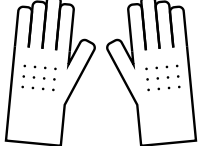
Tools			
 Clamp meter	 Multi-meter	 Label paper	 Phillips screwdriver
 Flat-headscrewdriver	 Socket wrench	 Adjustable wrench	 Torque wrench

Tools			
 COAX crimping tool	 Diagonal pliers	 Wire stripper	 Claw hammer
 Hammer drill	 Insulation tape	 Cotton cloth	 Brush
 Heat shrink tubing	 Heat gun	 Electrician's knife	 Protective gloves
 ESD gloves	 Insulated gloves	 Hydraulic pliers	 Cable tie

3.2.2 Install Environment

The installation environment of the UPS should be with good ventilation, and far away from water source, heat source and inflammable and explosive objects. Avoid installing the UPS in the place where has direct sunshine, dust, volatile gas, corrosive objects or high salt.

3.2.3 Install Space

The installation site should be with enough space to place the device. Maintain a clearance of at least 300mm from rear panel of the UPS to the wall or other device.

3.2.4 Select Breaker & Wires

The selecting for AC input and output wire, DC input wire and corresponding breakers needs to be judged by the UPS's max. steady state phase current. Table3-1 and Table3-2 shows the max. steady state phase current of each work mode, Table3-3 and Table3-4 shows the rated current of

recommended breakers, Table3-5 to Table3-9 shown the min. recommended wire cross-sectional area. Select the wires and breakers according to Table3-1 to Table3-9.

Table3-1 UPS max. steady state phase current

Type	MY10/10S/10T			MY15/15S/15T			MY20/20S/20T		
	33 mode	31 mode	11 mode	33 mode	31 mode	11 mode	33 mode	31 mode	11 mode
AC input (A)	19.5	19.5	58.6	27.5	27.5	82.5	35.5	35.5	106.4
Bypass input (A)	19.5	58.6	58.6	27.5	82.5	82.5	35.5	106.4	106.4
DC input (A)	54.8	54.8	54.8	41.1	41.1	41.1	54.8	54.8	54.8
AC output (A)	15.2	45.6	45.6	22.7	68.2	68.2	30.3	90.9	90.9

Table3-2 UPS max. steady state phase current

Type	MY30/30S/30T		MY40/40S/30T	
	33 mode	31 mode	33 mode	31 mode
AC input (A)	65.7	65.7	81.7	81.7
Bypass input (A)	65.7	197.1	81.7	245.0
DC input (A)	82.2	82.2	109.6	109.6
AC output (A)	45.5	136.4	60.6	181.8

3.2.5 Select Input Breaker

We suggest to add a breaker (we suggest to select the breaker with feedback double pole disconnection equipment) that matches the UPS power at the front of the UPS input to insulate the mains. Considering the UPS charge power and the impact current while power on, the selected breaker must be 1.5 to 2 times of UPS input max. current, and cannot with leakage protection, which is to avoid wrong action of breaker. The breaker of DC input should be select more than the 250V DC. The selection of breaker, please reference Table3-3 and Table3-4.

Table3-3 Recommended input breaker list

Type	MY10/10S/10T			MY15/15S/15T			MY20/20S/20T		
	33 mode	31 mode	11 mode	33 mode	31 mode	11 mode	33 mode	31 mode	11 mode
AC input (A)	32*3P	32*3P	80*1P	63*3P	63*3P	100*3P	63*3P	63*3P	150*3P
Bypass input (A)	32*3P	80*1P	80*1P	63*3P	100*3P	100*3P	63*3P	100*3P	150*3P
DC input (A)	100*3P	100*3P	100*3P	63*3P	63*3P	63*3P	100*3P	100*3P	100*3P
AC output (A)	32*3P	80*1P	80*1P	63*3P	100*3P	100*3P	63*3P	100*3P	100*3P

Table3-4 Recommended input breaker list

Type	MY30/30S/30T		MY40/40S/40T	
	33 mode	31 mode	33 mode	31 mode
AC input (A)	100*3P	100*3P	100*3P	100*3P
Bypass input (A)	100*3P	250*1P	100*3P	300*1P
DC input (A)	125*3P	125*3P	175*3P	175*3P
AC output (A)	100*3P	200*1P	100*3P	250*1P



CAUTION

Withstanding voltage value of recommended AC and Bypass input breaker and AC output breaker is 250Vac, DC input breaker is 250Vdc.

3.2.6 Select Wires

 **NOTE**

When the cross-sectional area of single wire is greater than 25mm^2 , it is recommended to connect two wires in parallel.

For the wire cross-sectional area of AC input, output and battery please see the recommended value in Table3-5, Table3-6 and Table3-7. The cross-sectional area of the following cable is only for reference when the user is connected wire for a length of about 5 meters. If the length of the lead wire exceeds 20 meters, the cross-sectional area of the conductor wire shall be increased.

Table3-5 Recommended cross-sectional area of wire (unit: mm^2 , environment temperature: 25°C)

	33 mode				
	MY10/10S /10T	MY15/15S /15T	MY20/20S /20T	MY30/30S /30T	MY40/40S /40T
Mains input live wire (U/V/W)	4	6	6	16	16
Mains input neutral wire (N)	4	6	6	16	16
Bypass input neutral wire (N)	4	6	6	16	16
Bypass input live wire (U/V/W)	4	6	6	16	16
Mains output live wire (U/V/W)	4	6	6	16	16
Mains output neutral wire (N)	4	6	6	16	16
DC input (+/BATN/-)	10	10	10	2*10	2*10
Grounding wire (PE)	4	6	6	16	16

Table3-6 Recommended cross-sectional area of wire (unit: mm², environment temperature: 25°C)

	31 mode				
	MY10/10S /10T	MY15/15S /15T	MY20/20S /20T	MY30/30S /30T	MY40/40S /40T
Mains input live wire (U/V/W)	4	6	6	16	16
Input neutral wire (N)	16	25	25	2*25	2*25
Bypass input live wire (L)	16	25	25	2*25	2*25
Mains output live wire (L)	16	25	25	2*25	2*25
Mains output neutral wire (N)	16	25	25	2*25	2*25
DC input (+/BATN/-)	10	10	10	2*10	2*10
Grounding wire (PE)	2*10	2*10	2*10	25	25

Table3-7 Recommended cross-sectional area of wire (unit: mm², environment temperature: 25°C)

	11 mode		
	MY10/10S/10T	MY15/15S/15T	MY20/20S/40T
Mains input live wire (L)	16	25	25
Input neutral wire (N)	16	25	25
Bypass input live wire (L)	16	25	25
Mains output live wire (L)	16	25	25
Mains output neutral wire (N)	16	25	25
DC input (+/BATN/-)	10	10	10
Grounding wire (PE)	2*10	2*10	2*10

Table3-8 Contrast list between wires and wiring terminals

Wire cross-sectional area (unit: mm ²)	Wiring terminal type
4	RVS3.5-5
6	RVS5.5-5
10	RNBS8-5
16	RNBS14-6
25	RNBS22-6

The wiring terminals recommend type as shown in Figure3-8. If users have additional terminals required, please check dimensions to ensure proper selection according to Table3-9.

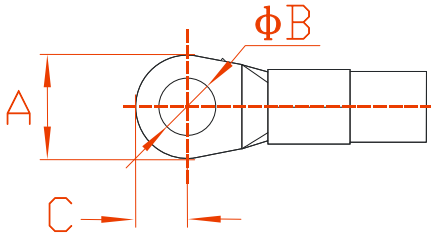

Figure3-1 Dimensions of wiring terminal

Table3-9 Dimensions limit of wiring terminal

Dimensions (unit: mm)	MY10/10S/10T/15/15S/15T/20/20S/20T	MY30/30S/30T/40/40S/40T
A	≤14.5	≤16.8
B	≥4	≥6.2
C	≤7.15	≤8.5

 **NOTE**

The equipped wires by our company are all passed the national standard or UL certification, the quality is perfect and meets the requirements of safety standard. Under the condition that the length is less than 0.5 meters, part of the wire is slightly smaller than the recommended specification, it can be used normally.

3.3 Transport and Unpacking

3.3.1 Transport



CAUTION

The UPS must be transported by trained professionals.

While transporting, please move gently and avoid impacting or dropping.

If the UPS needs to be stored for long time after unpacking, it is suggested to pack the device by original plastic bag.

The UPS can be transported by forklift and manual forklift. When lifting the device, the device's center of gravity should be at the centre of the forklift arm. Keep the devices moving slowly and stably.



Figure3-2 Forklift transportation

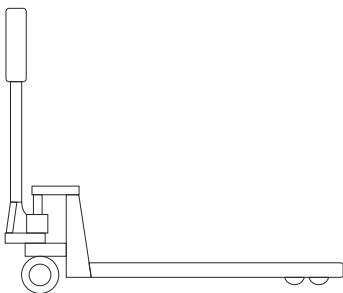

Figure3-3 Manual forklift transportation



CAUTION

During transporting, please take care and avoid impact or falling off.

During moving, keep the UPS vertical and do not put down or uplift suddenly.

3.3.2 Unpacking

 **NOTE**

Determine the unpacking site in advance. In principle, the unpacking site should be as close as possible to the installation site.

Step 1 Check if the package appearance is in good condition and if there is any damage caused by transportation. If damaged, please inform the carrier immediately.

Step 2 Transport the UPS to assigned site.

Step 3 Unpack the external package, and take out the fittings.

Step 4 Check the UPS.

- Inspect the appearance and check if there has any damage caused by transportation. If damaged, please inform the carrier immediately.
- Compare with the packing list and check if the fittings are complete and proper. If the fittings lack or model wrong, please take note and contact the local agency of our company.

Step 5 Put the front plate down to become an oblique board.

Step 6 After checking, unscrew the bolts that connected with the UPS and wooden bracket and the supporting plate by socket wrench, the bolt position as shown in Figure3-4, remove the supporting plate.

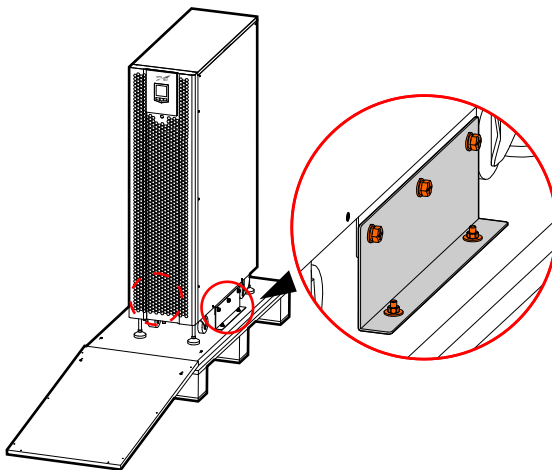

Figure3-4 Bolts position

 **NOTE**

The bolts position of MY series (10kVA-40kVA) is the same, above we take MY40 as an example to illustrate.

Step 7 Heighten the supporting feet, as shown in Figure3-5.

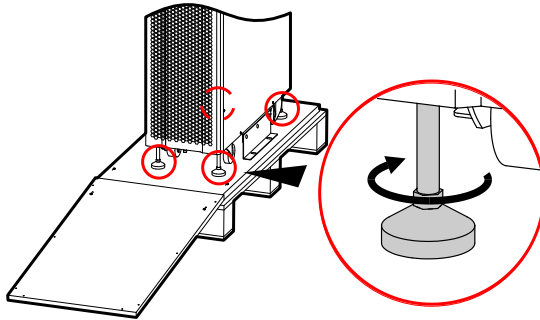

Figure3-5 Screw up the supporting feet brackets

 **NOTE**

Users who purchase UPS of MY series (10kVA-20kVA) don't need to operate this step for MY series (10kVA-20kVA) without support feet.

Adjust the support feet in clockwise to heighten the supporting feet, and adjust in anticlockwise to lower the supporting feet.

During operating, do not adjust one supporting foot only, adjust the four supporting feet in phase, which is to avoid tilting even device damage.

Step 8 Then slip the UPS along the oblique board to ground slowly.



CAUTION

During moving, it needs to operate by two people (one at left side and one at right side) to avoid tilting or human injury.

----End

3.4 Mechanical Installation

 **NOTE**

In this section, we take the ground perforation installation as an example, please adjust the installation procedure on the basis of actual condition.

Step 1 Determine and plan the installation position according to the device size (as shown in Figure3-6, Figure3-7) and install space requirement (see 3.2.3 Install Space).

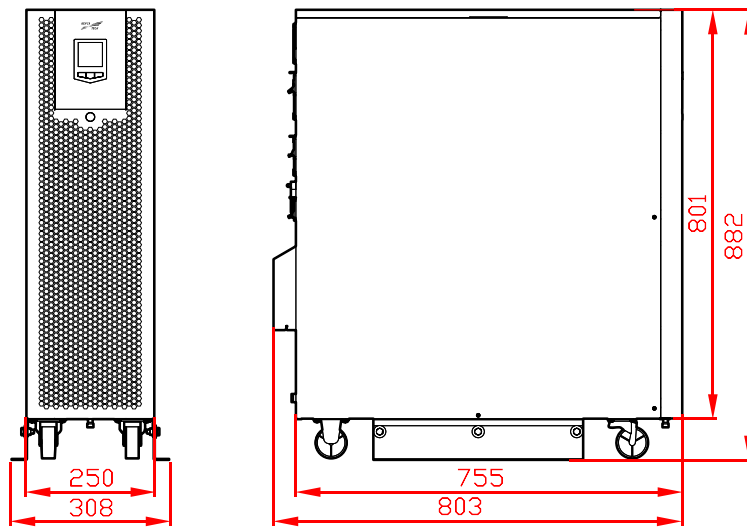

Figure3-6 Outer dimensions of UPS 10/10S/10T/15/15S/15T/20/20S/20T (unit: mm)

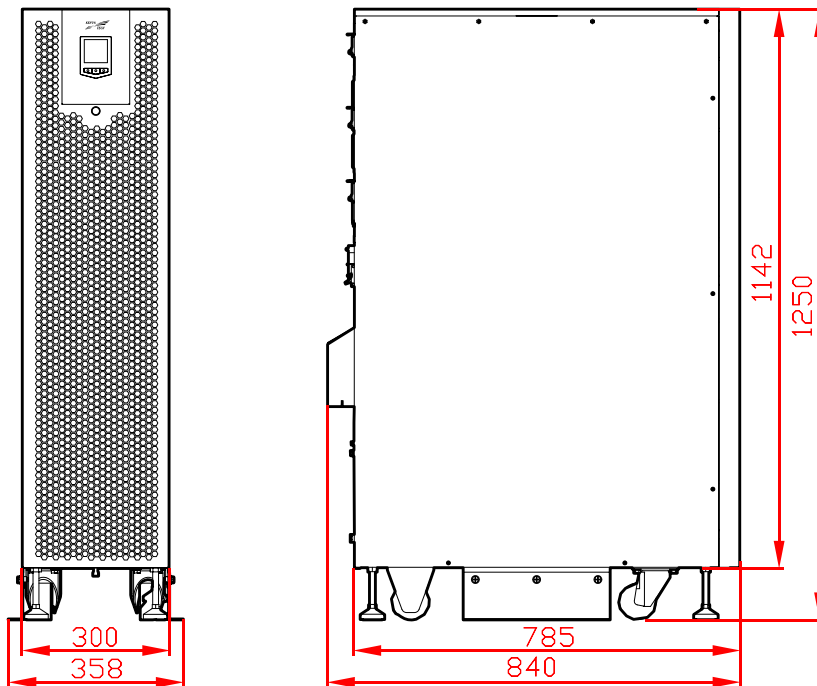

Figure3-7 Outer dimensions of UPS 30/30S/30T/40/40S/40T (unit: mm)

- Step 2 Drill $4\phi 10$ holes on the ground by impact drill according to the installation holes size of pedestal. The pedestal installation holes size of each model is as shown in Figure3-8, Figure3-9 (drilling deviation $\pm 2\text{mm}$). Install expansion bolts M8. The structure and installation for the expansion bolt is as shown in Figure3-10.

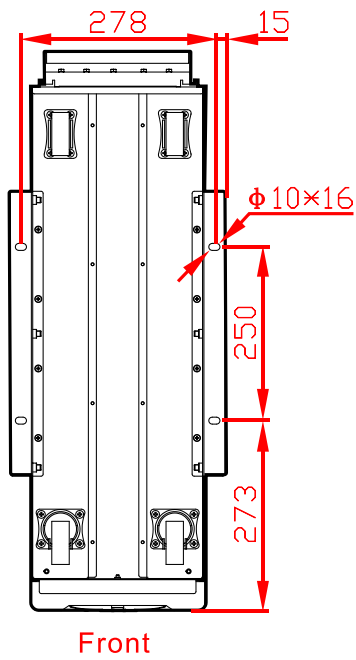

Figure3-8 10/10S/10T/15/15S/15T/20/20S/20T installation holes size of pedestal (bottom view, unit: mm)

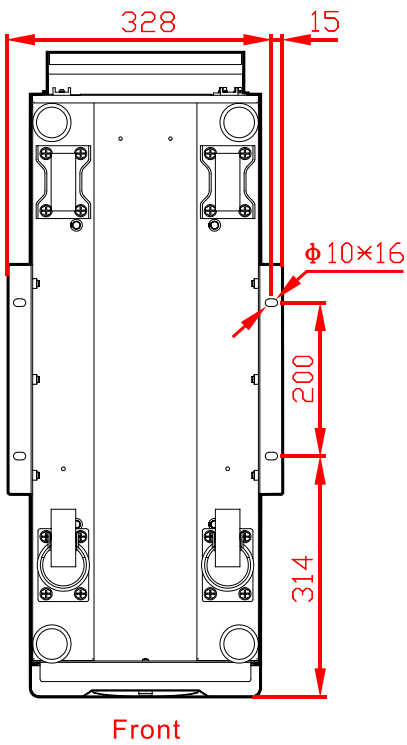
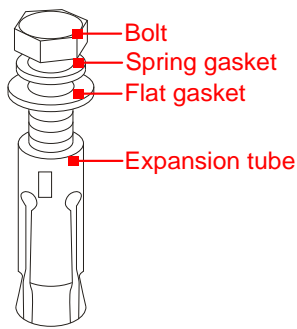

Figure3-9 30/30S/30T/40/40S/40T installation hole size of pedestal (bottom view, unit: mm)



1. Drill holes on the installation ground by hammer drill.
2. Tighten the expansion bolts mildly, and put it to the hole vertically, and then knock the expansion bolt by rubber hammer till all the expansion tube into the hole.
3. Pre tighten the expansion bolt.
4. Screw out the bolt, take down the spring gasket and flat gasket.

Figure3-10 Expansion bolt structure and installation

 **NOTE**

The exposed height of expansion bolt must be within 50mm.

Step 3 Move the UPS above the holes, pre-lock the supporting plate (not fully locked, leave one-third to two-thirds of the screws). Move and align the bottom installation hole of the supporting plate with the expansion bolt. Install the flat gasket ($\Phi 8$), spring gasket ($\Phi 8$) and screw the bolts. Tighten the UPS and the six unlocked screws of supporting plate.

Step 4 Then screw down the supporting feet anticlockwise of the UPS to parallel with ground (just for 30/30S/30T/40/40S/40T).



CAUTION

During moving the UPS, please move the device stably and avoid device tilting.

----End

3.5 Electrical Connection



WARNING

Before connecting, ensure that the external connected rear breakers of mains, battery are all off. DO NOT connect wires with electricity.

While wiring, avoid making the power wire at the place where is easy to be trod or tripped.

DO NOT move the UPS after connect wires.

3.5.1 UPS Wiring Operation

10/10S/10T/15/15S/15T/20/20S/20T

 **NOTE**

The wiring operation of MY series (10kVA-20kVA) is the same, below we take MY10 as an example to illustrate.

Step 1 Unscrew the bolt on the wiring cover, dismantle the wiring cover plate.

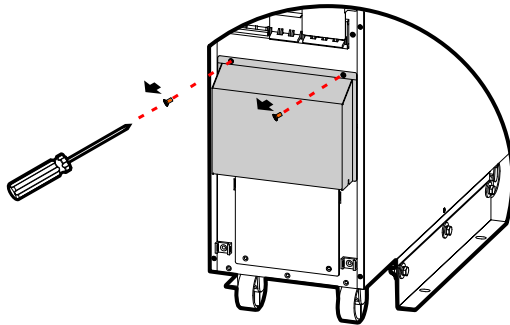

Figure3-11 Unscrew the bolt on the wiring cover plate

Step 2 The 10/10S/10T/15/15S/15T/20/20S/20T mode includes 33, 31 and 11, the corresponding silk-screen shown in Figure3-12. The wiring terminal of 33 mode, 31 mode and 11 mode have a little different, as shown in Figure3-13, Figure3-15 and Figure3-16.

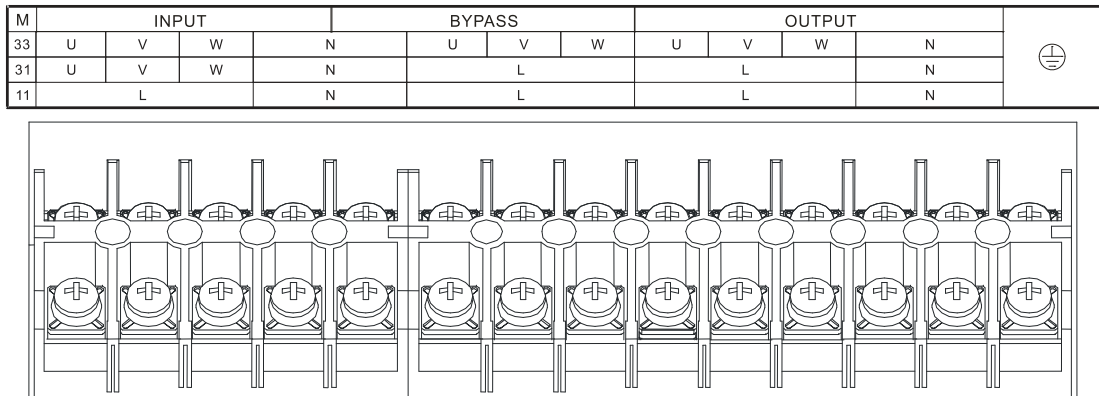

Figure3-12 Wiring terminal silk-screen

 **NOTE**

Three-phase identify methods adoption U, V, W. Corresponding to A phase, B phase and C phase or R phase, S phase and T phase.

- 33 mode

Wiring method 1: Different input sources for mains and bypass

The mains input and bypass input are connected separately when the mains input and bypass input have different input sources, as shown in Figure3-13.

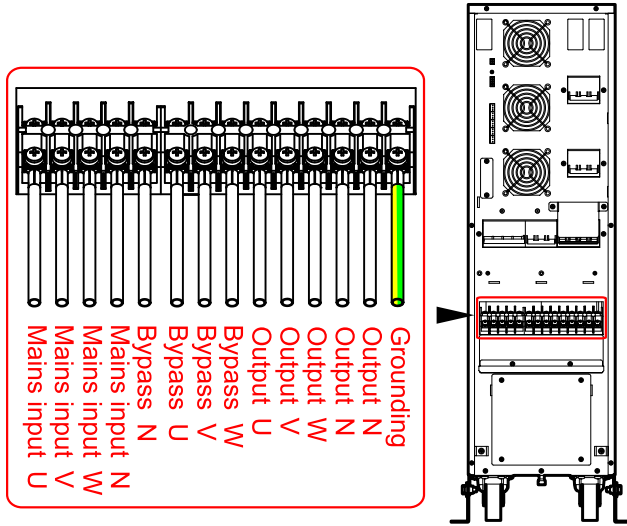

Figure3-13 Wiring diagram of 33 mode

Wiring method 2: One input sources for mains and bypass

The bypass input is connected to the mains input by short circuit wire when the mains input and bypass input are same sources, as shown in Figure3-14.

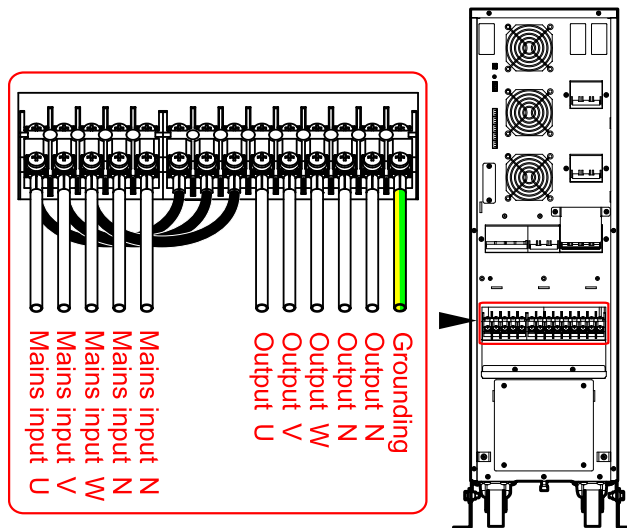

Figure3-14 Wiring diagram of 33 mode

- 31 mode

Take out a couple of 1# and 2# connector jumper (1# and 2# connector jumper is optional), connect them to the wiring terminal of UPS (as shown in Figure3-15). Then connect the wires to corresponding port according to the wiring diagram.

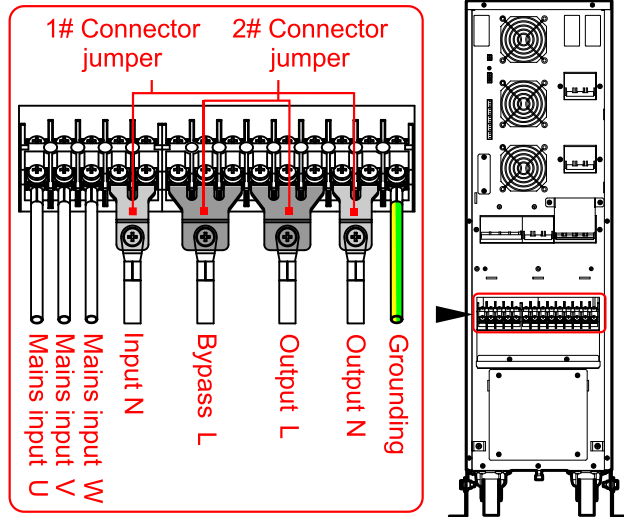

Figure3-15 Connector jumper and wiring diagram of 31 mode

- 11 mode

Take out a couple of 1# connector jumper and three 2# connector jumper (1# and 2# connector jumper is optional), connect them to the wiring terminal of UPS (as shown in Figure3-16). Then connect the wires to corresponding port according to the wiring diagram.

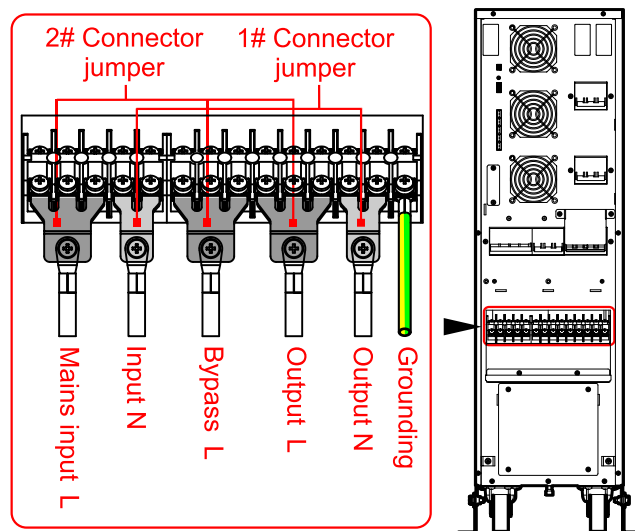

Figure3-16 Connector jumper and wiring diagram of 11 mode



CAUTION

When changing the mode of MY series (10kVA-20kVA), power down the UPS, the connection must be strictly according to the above step wiring. After completion, UPS is only connected to the mains and the bypass breaker must be disconnected. Set the wire (for LCD screen) or work configuration (for touch screen) on the screen display of the UPS is consistent with the actual wiring. After above operation is completed, please ensure that the wiring be consistent with wire (for LCD screen) or work configuration (for touch screen) of screen display, and then startup the UPS, close the bypass breaker after inverter output was normal.

Please refer to the 4.5.2 Function Setting of LCD screen or 5.5.8 Device Configuration Page of touch screen for corresponding screen display settings.

For example: the 33 mode settings of MY10 need to according to the wire diagram of 31 mode, and the wire (for LCD screen) or work configuration (for touch screen) of screen display is set to 33.



NOTE

When the input and bypass of 31/11 mode is different sources, the neutral wire (N) is connected to the input N terminal.

Please check to sure that all wire is connected correctly and without omission after wiring is completed.

Step 3 Replace the wiring cover.

----End

30/30S/30T/40/40S/40T



NOTE

The wiring operation of MY series (30kVA-40kVA) is the same, below we take MY40 as an example to illustrate.

Step 1 Unscrew the bolt on the wiring cover (as shown in Figure3-17), dismantle the wiring cover plate. Then unscrew the bolt on the connector cover (as shown in Figure3-18), dismantle the connector cover plate.

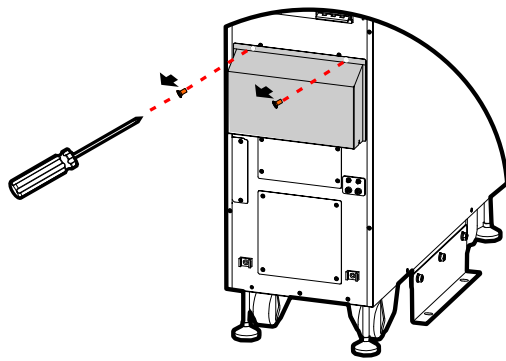

Figure3-17 Unscrew the bolt on the wiring cover plate

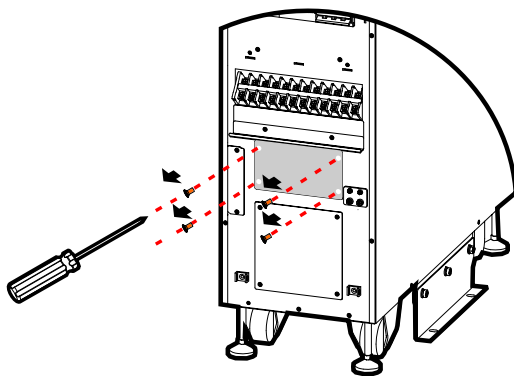

Figure3-18 Unscrew the bolt on the mode connector cover plate

Step 2 The 30/30S/30T/40/40S/40T mode includes 33 and 31, the corresponding silk-screen shown in Figure3-19. The default factory mode connector setting of the UPS is 33 mode (as shown in Figure3-20), the position of the mode connector and wiring terminal needs to be changed when the UPS mode to determines modify.

M	INPUT				BYPASS			OUTPUT				
33	U	V	W	N	N	U	V	W	U	V	W	N
31	U	V	W	N		L			L			N

Figure3-19 Wiring terminal silk-screen

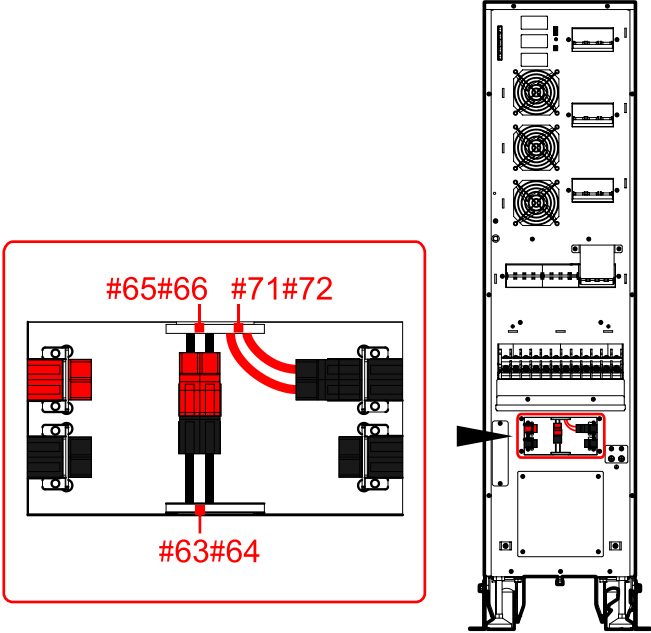

Figure3-20 Mode connector of default factory

- 33 mode

Wiring method 1: Different input sources for mains and bypass

The mains input and bypass input are connected separately when the mains input and bypass input have different input sources. The mode connector is default factory as shown in Figure3-20. Connect the wires to corresponding port according to the silk-screen. The wiring diagram of 33 mode UPS as shown in Figure3-21.

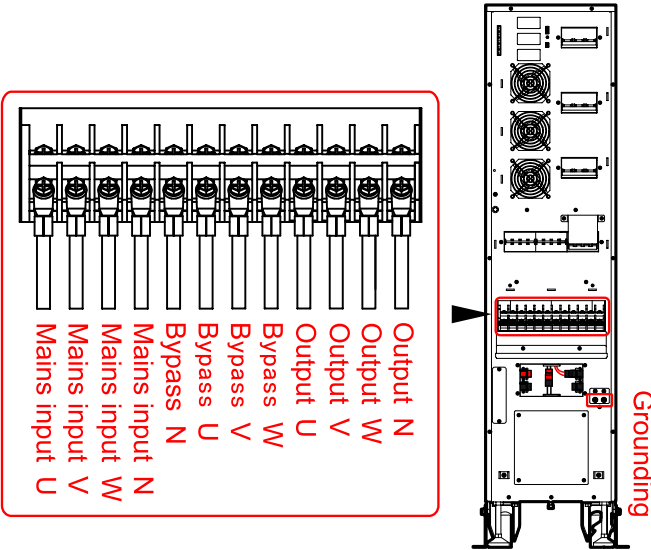

Figure3-21 Wiring diagram of 33 mode

Wiring method 2: One input sources for mains and bypass

The bypass input is connected to the mains input by short circuit wire when the mains input and bypass input are same sources. The mode connector is default factory as shown in Figure3-20. Connect the wires to corresponding port according to the silk-screen. The wiring diagram of 33 mode UPS as shown in as shown in Figure3-22.

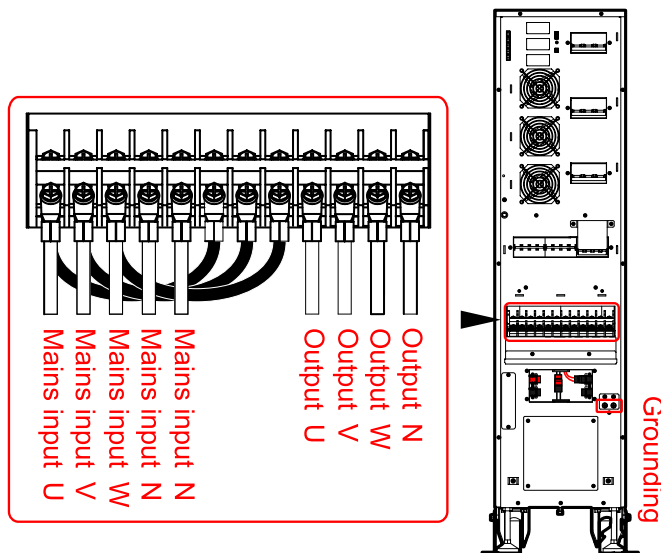

Figure3-22 Wiring diagram of 33 mode

- 33 mode switch over 31 mode

When the system of 33 mode need to be switch over the 31 mode, it is necessary to first pull out the mode connector (as shown in Figure3-23 ①), then insert it into the corresponding port (as shown in Figure3-23 ② ③). Take out three 3# connector jumper and one 4# connector jumper (3# and 4# connector jumper is optional), connect them to the wiring terminal of UPS (as shown in Figure3-24).

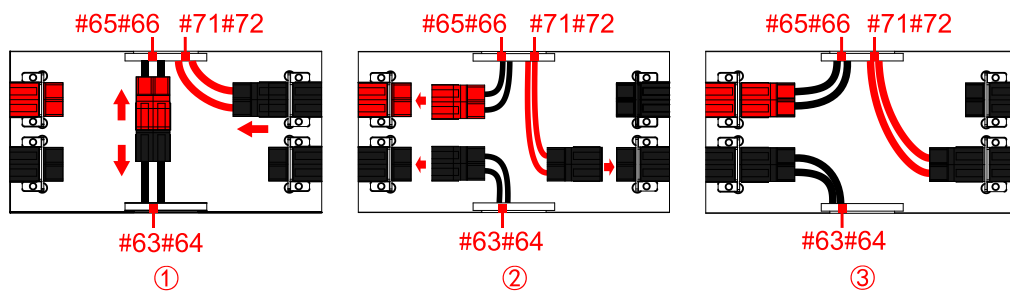

Figure3-23 Mode connector diagram of 31 mode

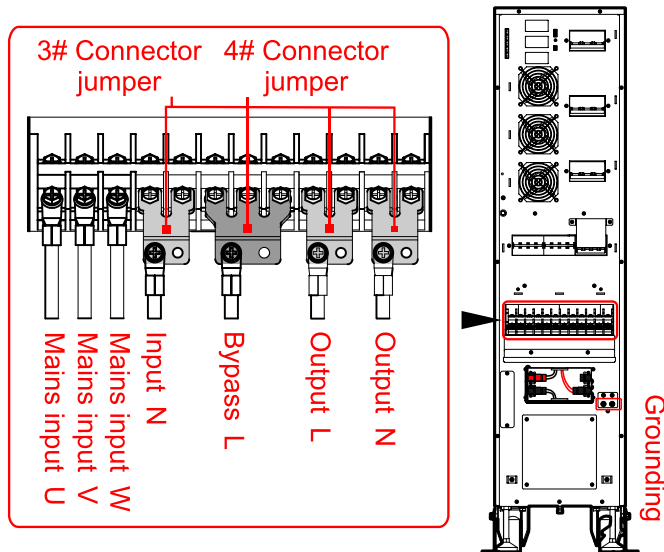

Figure3-24 Connector jumper and wiring terminal diagram of 31 mode

**CAUTION**

When changing the mode of MY series (30kVA-40kVA), power down the UPS, the connection must be strictly according to the above step wiring, mode switch over. After completion, UPS is only connected to the mains and the bypass breaker must be disconnected. Set the wire (for LCD screen) or work configuration (for touch screen) on the screen display of the UPS is consistent with the actual wiring. After above operation is completed, please ensure that the wiring and mode connector be consistent with wire (for LCD screen) or work configuration (for touch screen) of screen display, and then startup the UPS, close the bypass breaker after inverter output was normal.

Please refer to the 4.5.2 Function Setting of LCD screen or 5.5.8 Device Configuration Page of touch screen for corresponding screen display settings.

For example: the 31 mode settings of MY40 need to according to the wire and mode connector diagram of 31 mode, and the wire (for LCD screen) or work configuration (for touch screen) of screen display is set to 31.

**NOTE**

When the input and bypass of 31 mode is different sources, the neutral wire (N) is connected to the input N terminal.

Please check to sure that all wire is connected correctly and without omission after wiring is completed.

Step 3 Replace the mode connector cover plate first, and then replace the wiring cover plate.

----End

3.5.2 Wiring Between UPS and External Battery

NOTE

You can connect with external battery when you purchase internal battery of the UPS to prolong back-up time.

You must connect with external battery when you purchase without internal battery of the UPS.

This series UPS's battery input adapt positive and negative battery group (10/10S/10T battery group default has 8-20 positive cell and corresponding negative cell, and 15/15S/15T/20/20S/20T/30/30S/30T/40/40S/40T battery group default has 12-20 positive cell and corresponding negative cell). There are three wiring ways of external battery group.

Figure3-25 shown first wiring way: one battery cabinet has 32 cells and one 3P breaker, the external wiring includes BATT.+, BATT.- and battery neutral wire.

Figure3-26 shown the second wiring way: there are 32 cells separately in two independent battery cabinets, every battery cabinet has one 3P breaker, the external two wiring includes BATT.+, BATT.- and battery neutral wire.

Figure3-27 shown the third wiring way: there are 32 cells separately in two independent battery cabinets, every battery cabinet has one 3P breaker, the external two wiring includes BATT.+, BATT.- and battery neutral wire.

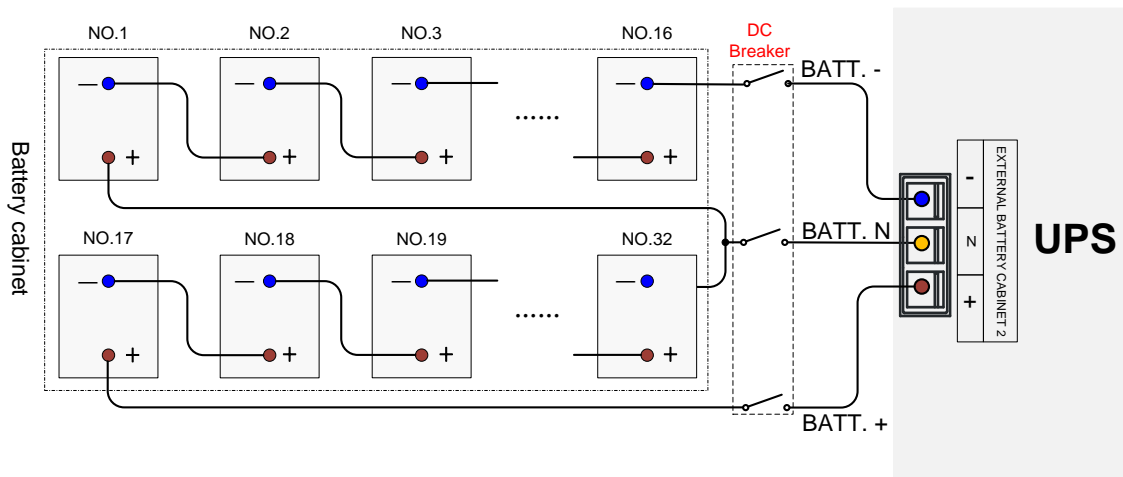

Figure3-25 Wiring diagram 1 of external batteries

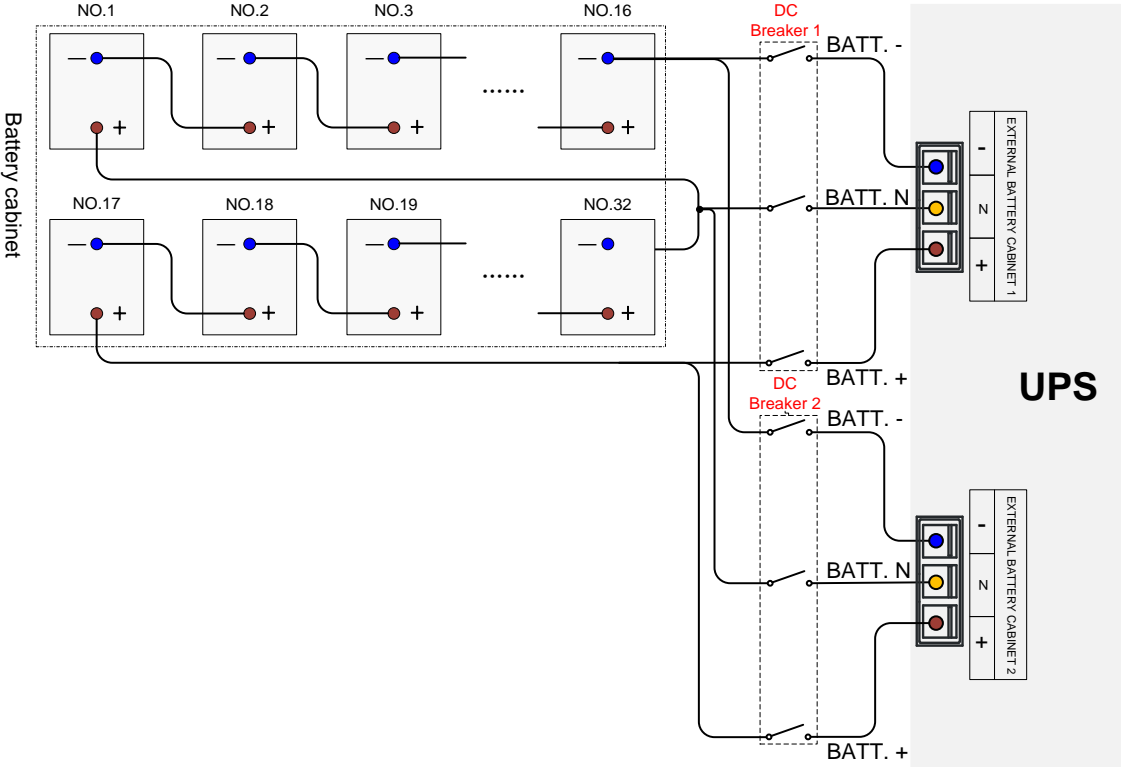

Figure3-26 Wiring diagram 2 of external batteries

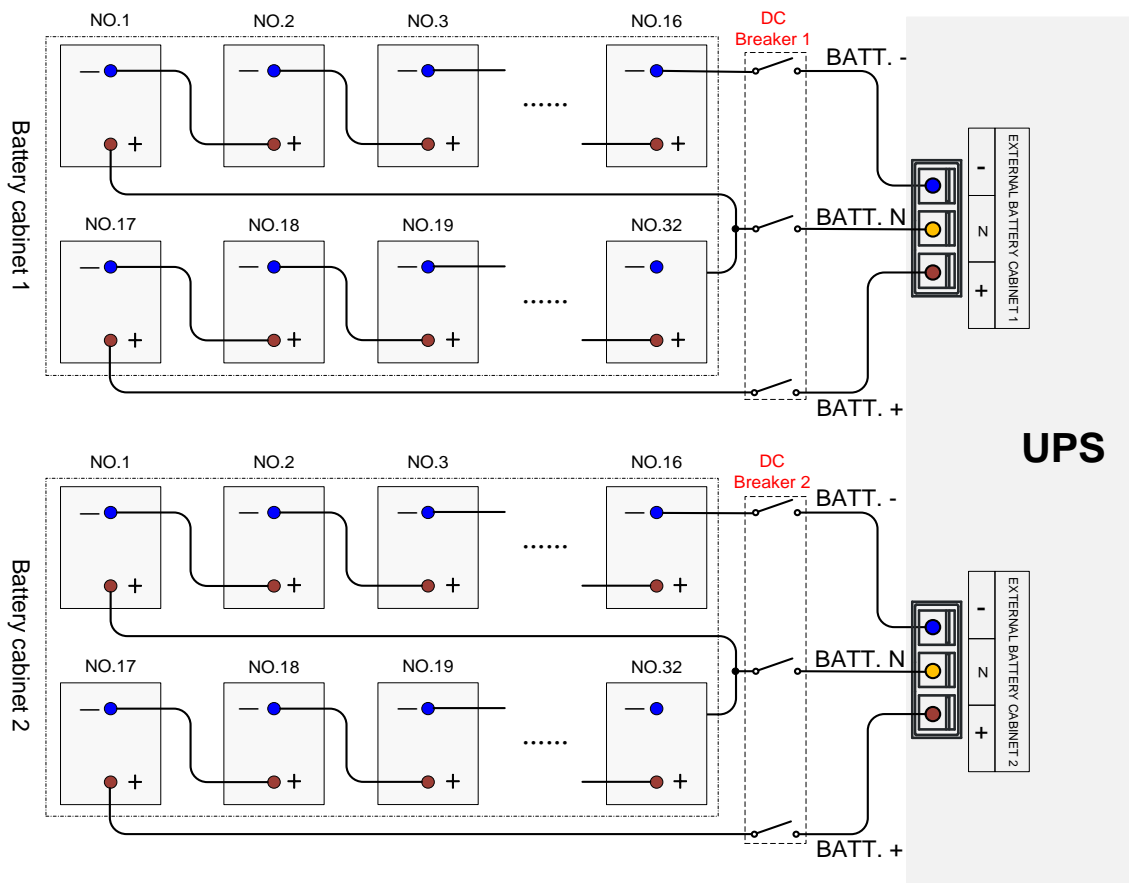

Figure3-27 Wiring diagram 3 of external batteries

NOTE

When the two battery cabinet is shared by two external battery cabinets of UPS, please make sure that all battery parameters of each UPS are consistent, such as battery branding, battery capacity, battery number and battery voltage.

Extension battery wiring assembly (optional)

Extension battery wiring assembly is optional when the UPS need to connect with external battery, the installation as shown in Figure3-28.

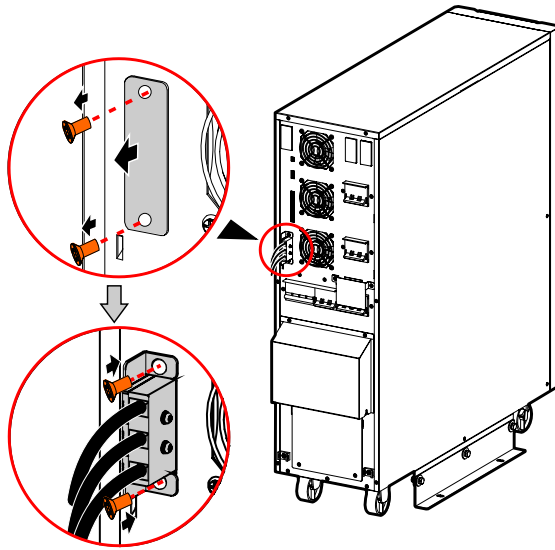

Figure3-28 Extension battery wiring assembly of MY10

NOTE

The extension battery wiring assembly can optional one-meter or three-meter wiring according to actual need.

Above we take MY10 as an example to illustrate. MY series (30kVA-40kVA) have two external battery ports and the position is different with MY10, which the installation method is the same as MY10.

3.5.3 Wiring of Parallel System

NOTE

The parallel function requires parallel kit (optional) for the standard UPS model is single equipment.

- Step 1 Install the battery and UPS of parallel system separately according to 3.4 Mechanical Installation.
- Step 2 Connect the wires of input, bypass, output and battery in parallel system on the basis of Figure3-29 to Figure3-33.

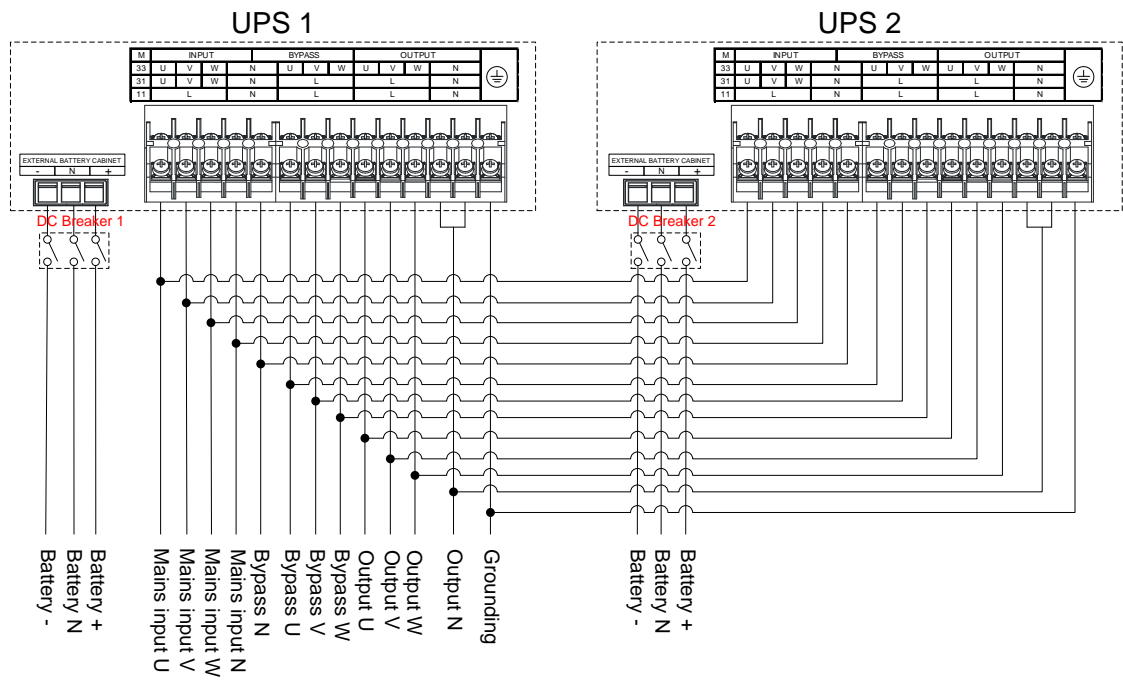

Figure3-29 33 mode parallel system wiring diagram of 10/10S/10T/15/15S/15T/20/20S/20T

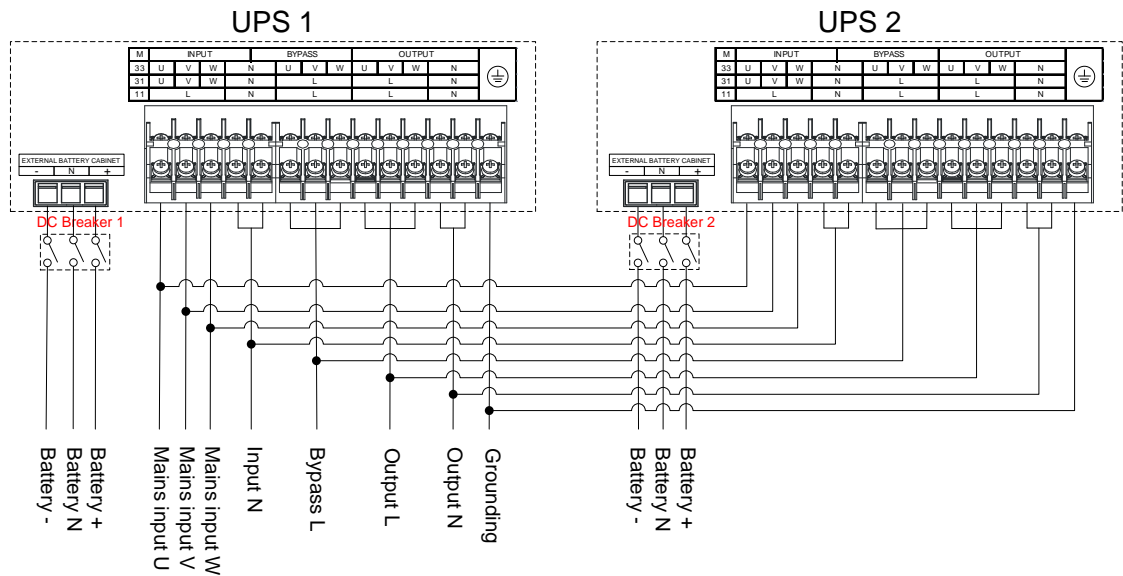

Figure3-30 31 mode parallel system wiring diagram of 10/10S/10T/15/15S/15T/20/20S/20T

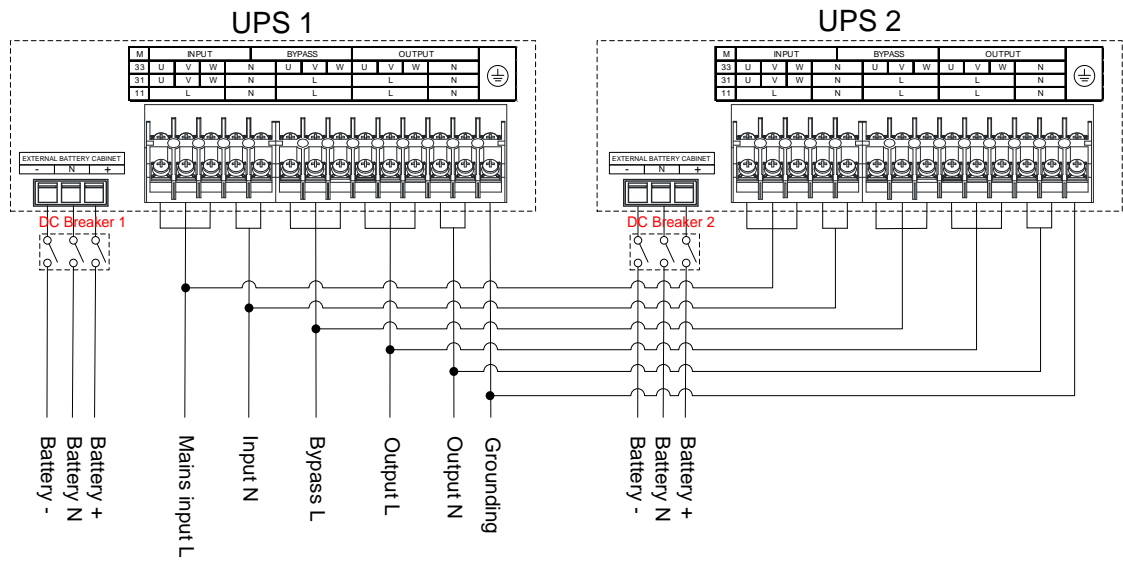

Figure3-31 11 mode parallel system wiring diagram of 10/10S/10T/15/15S/15T/20/20S/20T

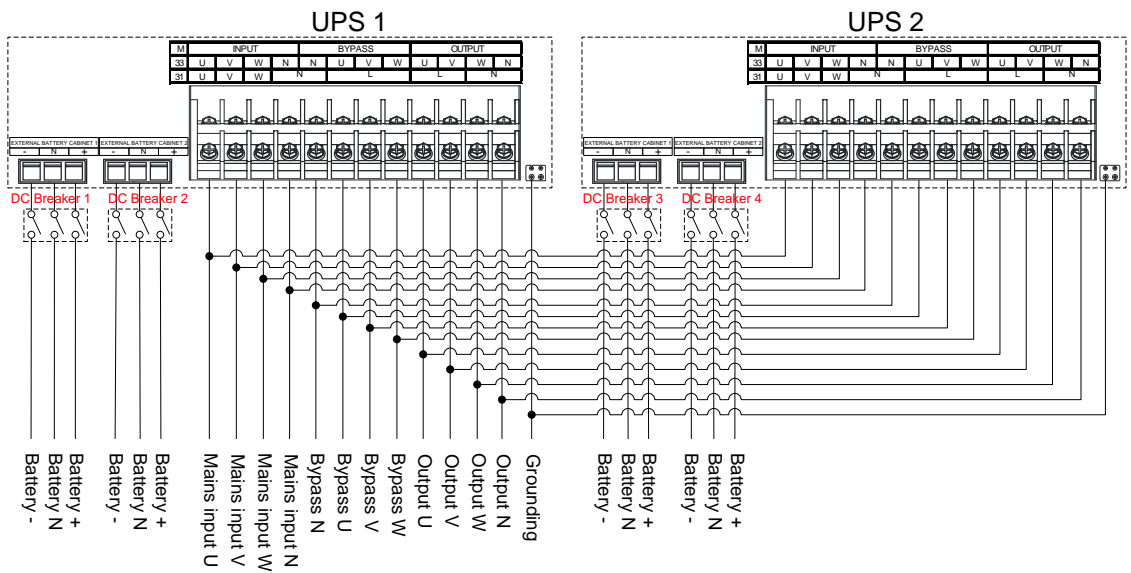

Figure3-32 33 mode parallel system wiring diagram of 30/30S/30T/40/40S/40T

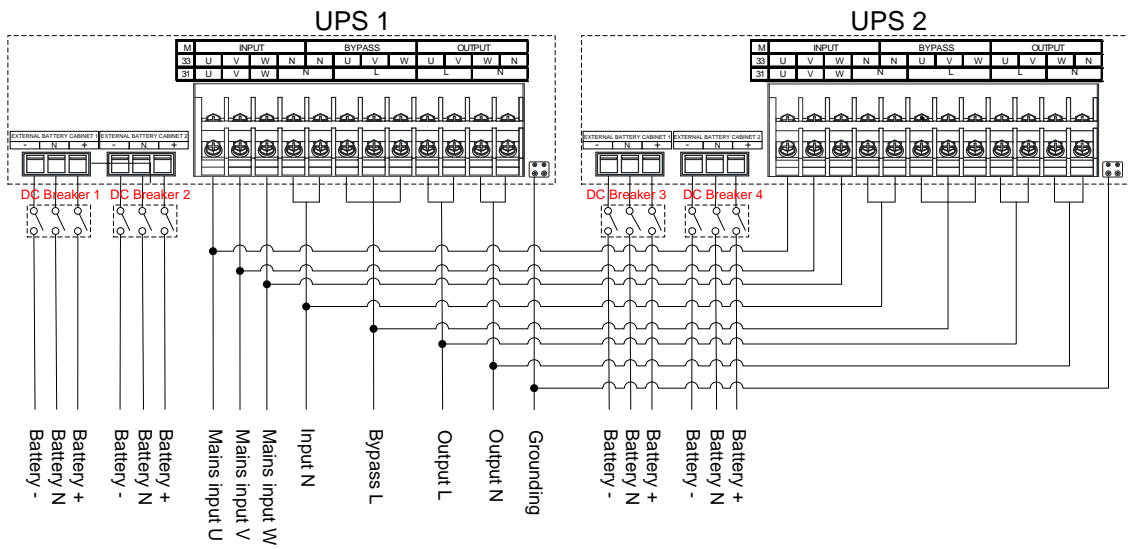

Figure3-33 31 mode parallel system wiring diagram of 30/30S/30T/40/40S/40T

Step 3 Connect the parallel port of each UPS in parallel by parallel wires, as shown in Figure3-34 and Figure3-35.

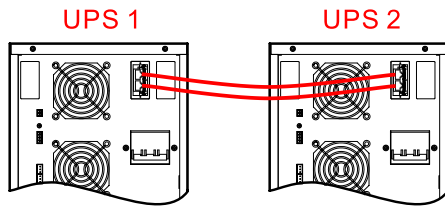

Figure3-34 Double parallel wiring diagram of MY10

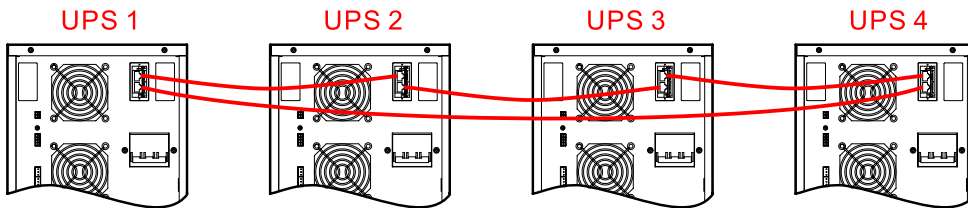

Figure3-35 Four parallel wiring diagram of MY10

NOTE

The parallel wiring operation of MY series (10kVA-40kVA) is the same but the parallel port position of MY series (30kVA-40kVA) is different with MY10, above we take MY10 as an example to illustrate.

When the battery pack is shared by UPS in the parallel system, please make sure that all battery parameters of each UPS are consistent, such as battery capacity, battery number, charging voltage and charging current.

**WARNING**

The wiring and phase sequence of each UPS in the parallel system must be the same strictly.

The parallel system of this series UPS can share battery groups, but the battery amount of each UPS must be the same.

---End

4 LCD Screen Operation

This chapter mainly introduces the working parameters, working status and system settings of UPS LCD screen.

4.1 Menu Hierarchy

The menu hierarchy of the LCD is as shown in Figure4-1.

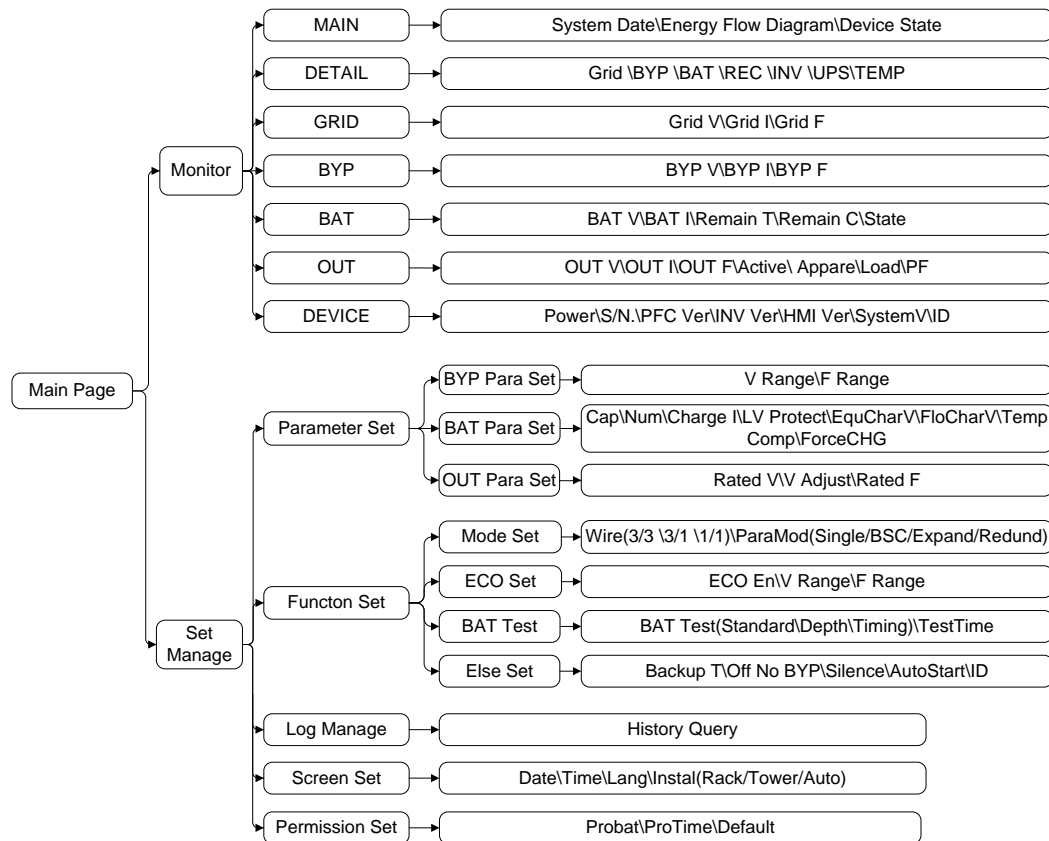

Figure4-1 Menu hierarchy of the touch screen

NOTE

The parameter values and other details in the pictures in this chapter are for illustration only. The actual parameters should be based on the LCD of the product.

4.2 Main Page

After the UPS is powered on, it will enter the system monitoring main interface, as shown in Figure4-2, the interface default display energy flow chart.

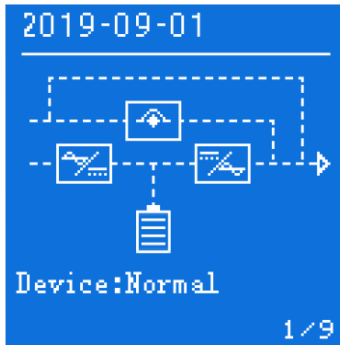





Figure4-2 Main page

After entering the main interface, it is easy to monitor the system. The meaning of the icons on the main interface is as follows:

: System bypass icon.

: System rectifier icon.

: System inverter icon.

: System battery icon. The internal energy bar of the battery changes accordingly depending on the current battery status and battery voltage.

: System current date display.

: System current operating status display.

: Monitor page number display.

The working state and energy flow on the main interface visually describe the operating state of the system.

4.3 System Working Status Display

The operating status of the system have 4 modes: main power inverter output, battery inverter output, ECO bypass output, maintenance bypass output. Interface display for each working status as shown in Figure4-3 to Figure4-6.

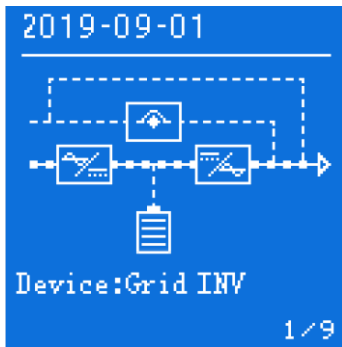

Figure4-3 Main power inverter output

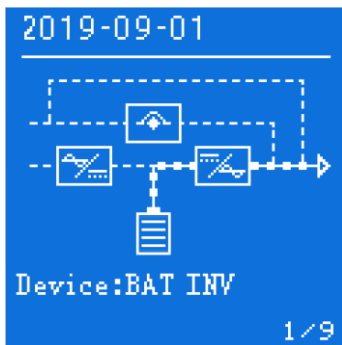

Figure4-4 Battery inverter output

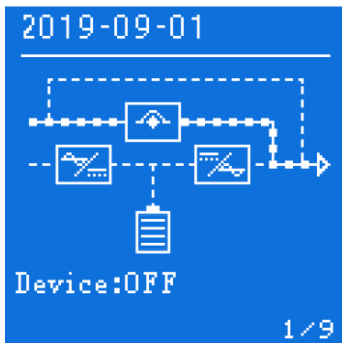

Figure4-5 ECO/Bypass output

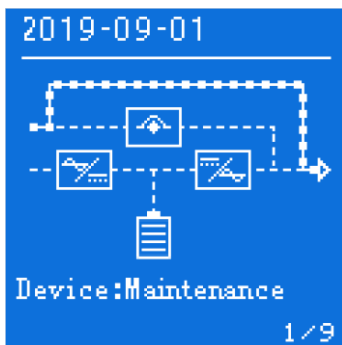

Figure4-6 Maintenance bypass output

4.4 Monitoring Page

After the system automatically enters the monitoring page, the monitoring page in the lower right corner shows page number. The total number of monitoring pages displayed is changes depending on the current set of different system mode. By pressing the up/down page button, you can achieve the monitoring page loop display. 33 mode page number and page loop order as shown in Figure4-7. There are some differences in the 31/11 mode display and 33 mode display, the actual displayed should be based on the actual interface.

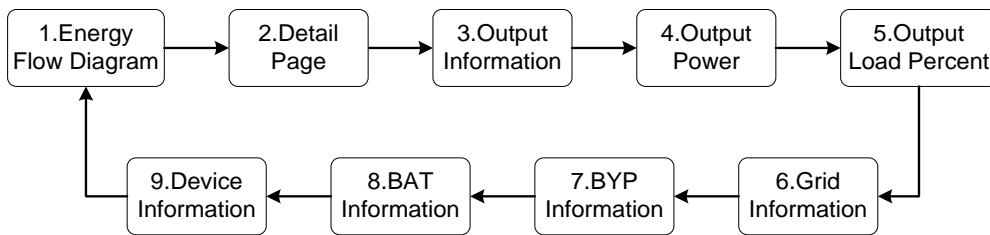

Figure4-7 33 mode page number and page loop order

4.5 Setting Management

In any monitoring page by long pressing "□" button for 3s can enter the settings management page, the page is mainly for the directory display function, the page display includes: parameter set, function set, log manage, screen set and permission set five items, as shown in Figure4-8. Each item has a hollow box icon "□" before it, and if the item is selected, the hollow box icon becomes a solid box "■" icon. You can select page content by pressing the up/down page button. When you select the back button "←" to the lower right corner, the back button is selected and appears as an opposite color status "←".

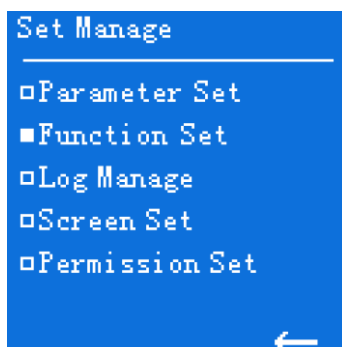

Figure4-8 Set manage page

After the page option selection is complete, short press the "□" button to go to the corresponding next settings page. When you select the back button "←" in the settings management page and press the "□" button shortly, the display takes you to the previous page.

4.5.1 Parameter Setting

In the settings management page, select the "Parameter Set" option, and short press the "□" button shortly to enter the parameter settings page, which is a second class page, mainly for the directory display function, the page display includes: bypass parameter settings, battery parameter settings and output parameter setting three, as shown in Figure4-9 and Figure4-10.

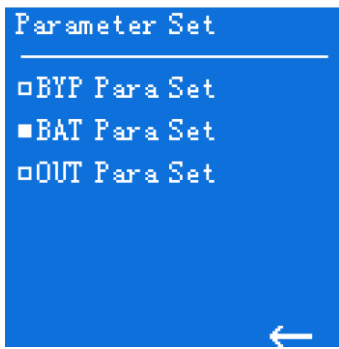

Figure4-9 Parameter setting page

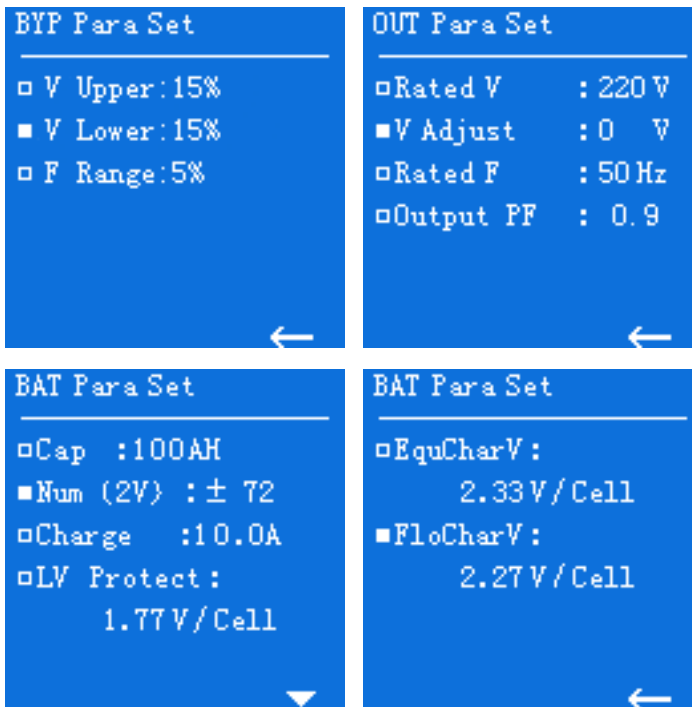

Figure4-10 Details of parameter setting page

By shortly pressing the up/down page button to achieve the page option selection, the selected option in front of the hollow box will become a solid box, at this time short press "□" button can go to the corresponding next level of settings page. When you select the back button at the lower right corner, the return button is displayed as an opposite color state, and this time, short press "□" button can go

to the previous level of the page, and the previews class parameter settings page is the settings management page.

There are four next level pages on the parameter settings page, one bypass parameter settings page, two battery parameter settings pages, and one output parameter settings page. In the battery parameter page, you can select the setting options by short pressing the up/down page turning button. After the option selection is complete, such as selecting "number of sections", you can enter the setting of the number of sections by short pressing the "0" button, the number of sections displayed "20" will flash, and this time, you can set the section number minus/plus by pressing the up/down page turning button. When the section number is adjusted to the value to be set, the section number setting can be completed by the short pressing the "0" button.

4.5.2 Function Setting

In the Settings Management page, select the "Function Set" option, and short press the "0" button to enter the function settings page, and it mainly for the directory display function, the page display includes: mode set, ECO set, battery test and else set four items, as shown in Figure4-11.

By shortly pressing the up/down page button to achieve the page option selection, the selected option in front of the hollow box will become a solid box, at this time short press "0" button can go to the corresponding next level of settings page. When you select the back button in the lower right corner, the return button is displayed as an opposite color state, at which point the short press "0" button can go to the previous level of the page, and the previews class function settings page is the settings management page.

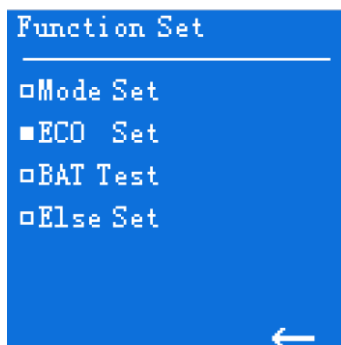

Figure4-11 Function setting page

There are four next-level pages on the function set page, and the page display includes: mode set, ECO set, battery test and else set four items, as shown in Figure4-12.

The following is to take the battery test page as an example, explain the three-level page setting method, the rest of the page setting method is the same, will not repeat the story.

On the battery test page, you can select the options by short pressing the up/down page button, and after selecting "Standard Test", you can enter the settings for the standard test by short pressing the " " button, at which point the standard test option "Off" flashes.

The on/off option switch can be performed for the standard test, and after adjusting to the specific option, the standard test can be completed by short pressing the " " button.

Because the current three battery tests cannot be performed at the same time, when one battery test is set to on, the options for the other two battery tests automatically appear to be off. In addition, since the discharge time setting is only available under the timing test conditions, when the timing test is set to off, the discharge time item is not displayed.

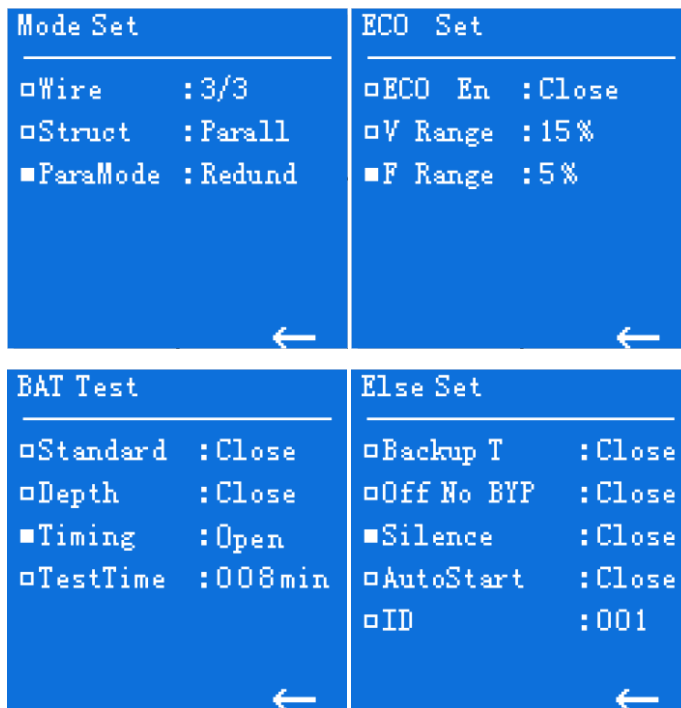

Figure4-12 Details of function setting page

NOTE

Battery test settings: standard test is that UPS return to the electrolytic inversion after turning to battery inverter for 10s at power-on state, and the depth test is that UPS to go to battery inversion until the battery discharges to the under-voltage alarm, and then returns to the main power inverter.

Back-up time display settings: when there are other more accurate battery remaining discharge time monitoring devices in the system, you can choose to turn off the battery residual discharge time display function of the UPS itself.

Call self-start setting: manual mode is that human shutdown needs to be re-manual power edged to trigger the UPS self-start function after the power generation, automatic mode is as long as the normal power generation UPS is self-starting, under this condition UPS shutdown can only be manually shut down when the battery is reversed, suitable for unattended applications.

4.5.3 Log Management

In the Settings management page, select the "Log Management" option and short press the "□" button to enter the log management page, the page main display is history query and customized parameters (the actual parameters display should be based on the LCD of the product).

4.5.4 Screen Setting

In the Settings management page, select the "Screen Settings" option, and short press the "□" button to enter the screen settings page, the page is a three-level page, the page display includes: date settings, time settings, language settings, display mode settings four items, as shown in Figure4-13.

The page option selection can be achieved by pressing the top/bottom page button shortly, and the hollow box in front of the selected option becomes a solid box. When you select the back button in the lower right corner, the back button is displayed as an opposite color state, at which point the short press "□" button can go to the next level of the page, and the previous level page on the screen settings page is the settings management page.

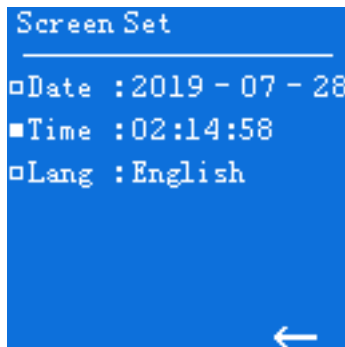

Figure4-13 Screen set page

On the screen settings page, select "Date" and short press the settings button will enter the date settings, where "2019" in the date will flash, and when flashing, you can set the section number minus/plus by pressing the up/down page turning button. After the section number is adjusted to the value to be set, you can short press the "□" button to enter the month setting in the date. When entering the month setting, the value "07" corresponding to the month will flash, user can set the month number minus/plus by short pressing the up/down page turning button when the month is flashing, short press "□" button to enter the day setting in the date after adjusting the month number to the corresponding number. The same is true, when entering the day setting, the value "28" corresponding to the day will flash, user can set the day number minus/plus by short pressing the up/down page turning button when the day is flashing, short press "□" button to finish the date setting after adjusting the day number to the corresponding number.

The time setting, language settings are the same as the date settings, and it will not be repeated here.

4.5.5 Permission Setting

In the Settings management page, select "Permission" option to enter the password entry page first, as shown in Figure4-14.

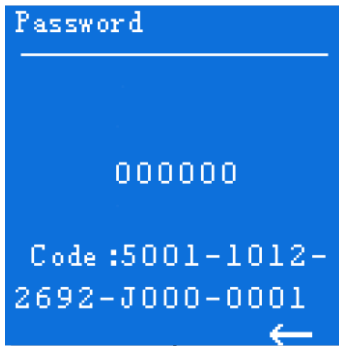

Figure4-14 Password input page

By short pressing the up/down page button to achieve page option selection, when selecting the lower right corner of the back button, the return button will be displayed as an opposite color state, at this time short press function button can enter the page to the previews level of the page, the password input page on the previews level of the page for the settings management page.

In the password input page, short press "" button can enter the password settings, at this time the first password flickering from the left, by short press the up/down page button can achieve the first bit password value minus/plus operation, select the required value, then short press "" button into the second bit password settings. The second to sixth bit password is set the same way, which is not repeated here. The password input range is 000000-999999.

After the sixth bit passwords is entered, press the "" button shortly, at which point if the password entered does not match the current system password, the screen will display the word "password error", and if the password entered matches the current system password, the system will enter the permission set page according to the current input password permission.

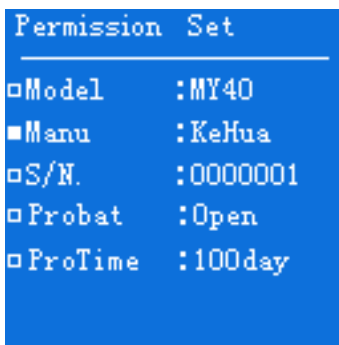

Figure4-15 Permission setting page 1

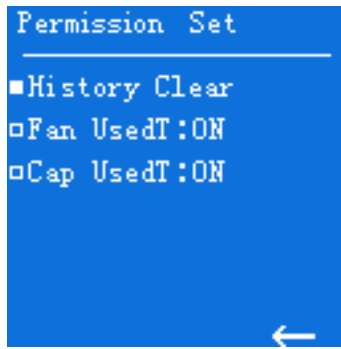

Figure4-16 Permission setting page 2

The permission set page includes trial function and trial time two setting items, and the trial time will not be displayed until the trial function is turned on. By pressing the up/down page button and working with the function button's short press operation, you can set the trial function and the trial time, the setting method is the same as the other settings mentioned above, and it is not repeated here.

By touch screen, user can easily browse the input, output, load, and battery parameters of the UPS and know the current status and warning information of UPS in time and control UPS. And also it can provide historical alarm log for users, which provide a reliable basis for fault diagnosis.

 **NOTE**

1. The permission set is a restricted operation, if you need this operation, you need to obtain the trial period password from the service provider;
2. The way for obtain the trial period password: after the service provider agrees, report the series number on the password input page (as shown in Figure4-14), then you can obtain the corresponding passwords.

5 Touch Screen Operation

In the touch screen, user can scan input parameter, output parameter, load parameter, battery parameter, get UPS status and warning information and perform relative setting. Besides, it also can query event log for fault diagnosis.

**NOTE**

The parameters values and other details in the pictures in this chapter are for illustration only. Detailed information should be base on the touch screen of the product.

5.1 Menu Hierarchy

The menu hierarchy of the touch screen is as shown in Figure5-1.

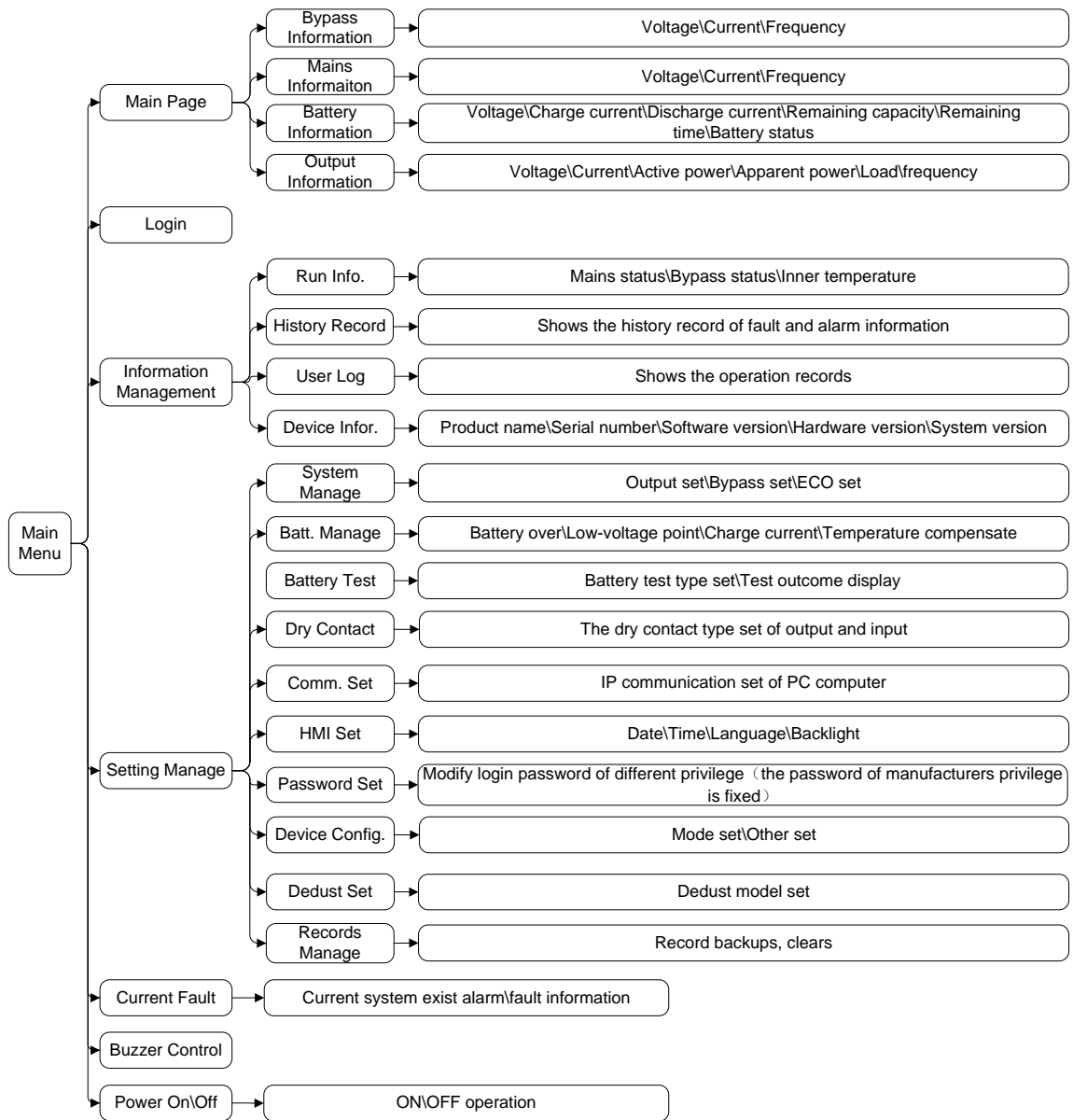

Figure5-1 Menu structure of the touch screen



WARNING

The touch screen contains parameters related to the operation of the device. All settings such as modification of parameters must be done by a designated professional. For parameters with unclear meanings, please refer to this book or consult relevant staff of our company. Please do not modify without authorization.

5.2 Main Page

After powering on, the touch screen will enter initialize. Then will enter system monitoring main page after powering on, as shown in Figure5-2.

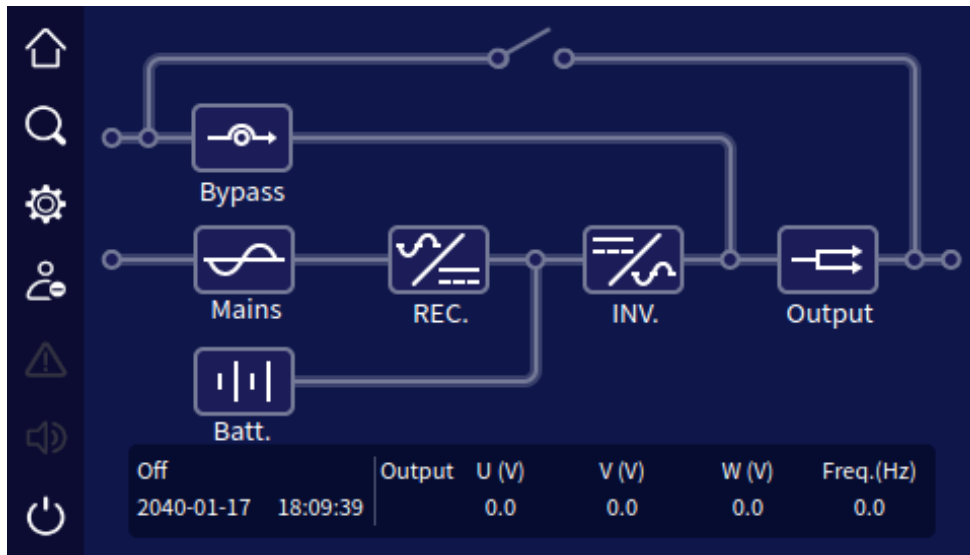













Figure5-2 Main page

5.2.1 Icon Meaning

In the main page, it shows the topological structure of UPS. The icon meaning is as follows:

- : Homepage. Click the icon in any page, it will return to the main page.
- : Information management. Click the icon it will enter the information management page.
- : Setting management. Click the icon, it will enter the setting management page.
- : Current fault information. If there is any fault, click the icon, you can check the corresponding fault information.
- : Buzzer. Click the icon to control the buzzer.
- : Login.
- : ON/OFF.
- : Bypass information. When bypass abnormal, the icon will be on and show in red.
- : Mains information. When mains abnormal, the icon will be on and show in red.
- : Battery information. When battery abnormal, the icon will be turn on and show in red.

: Output information. When output abnormal, the icon will be on and show in red.

5.2.2 Working Status

There are six main working statuses: without energy transmission status, mains inverting status, battery inverting status, bypass output status, ECO output and maintenance bypass output status. The corresponding water lights in the monitoring page are shown in Figure5-3 to Figure5-8. Besides, other statuses also have corresponding indicator instruction.

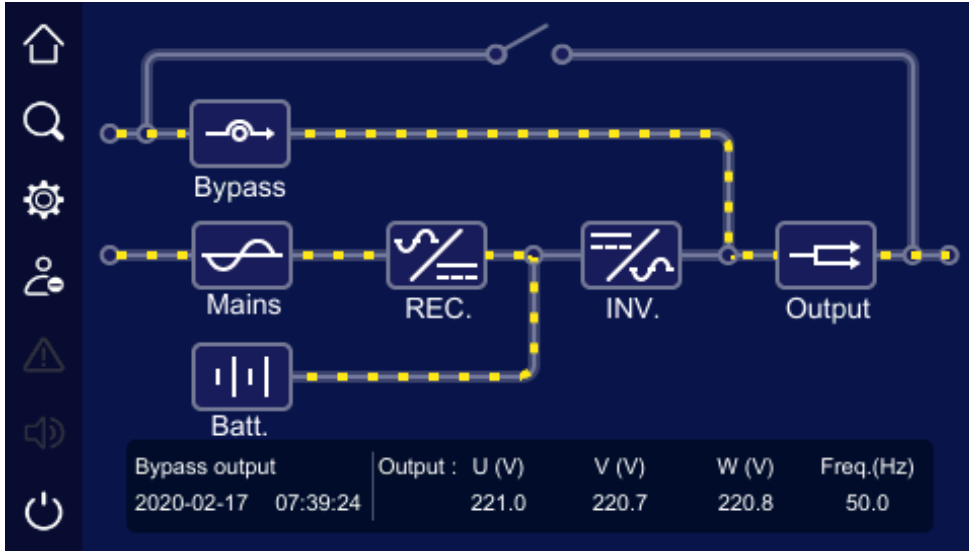

Figure5-3 Without energy transmission status

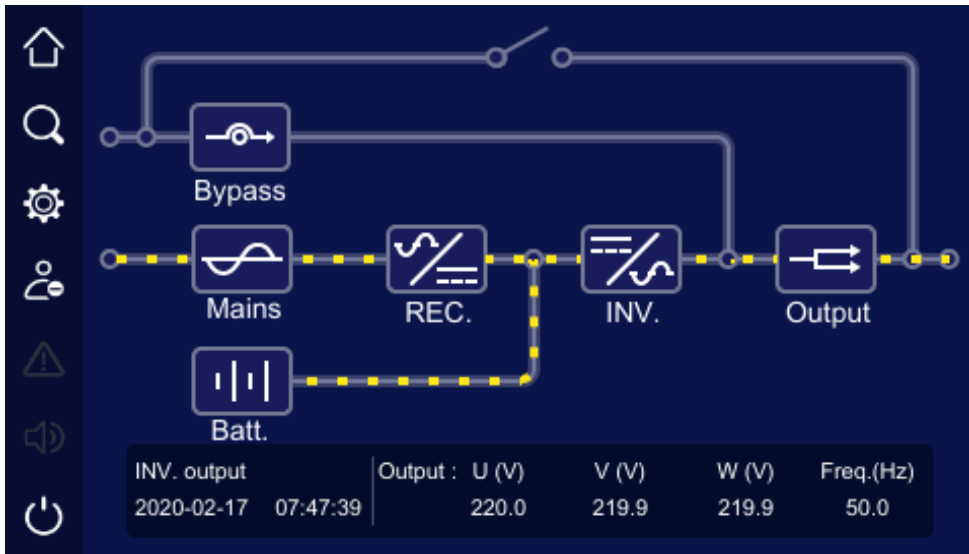

Figure5-4 Mains normal, mains inverting status

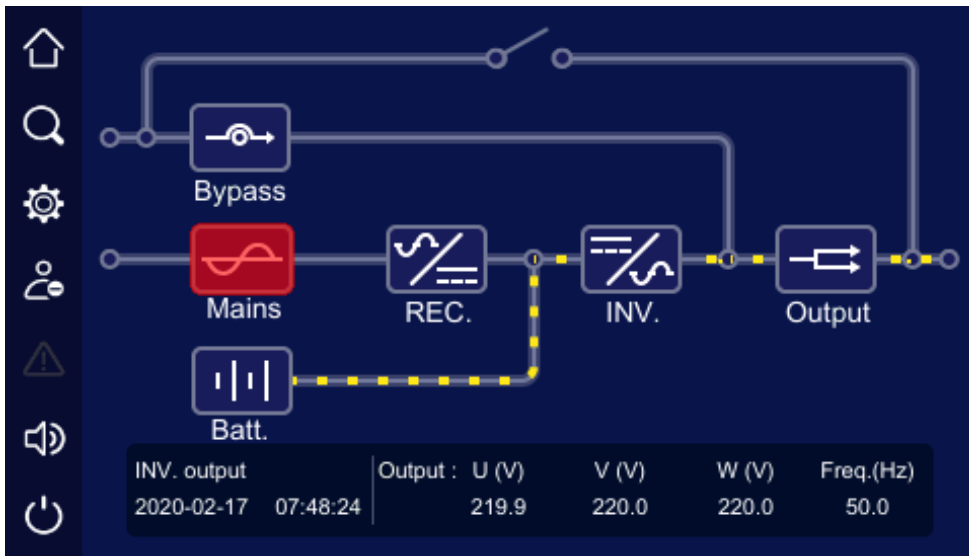

Figure5-5 Mains abnormal, battery inverting status

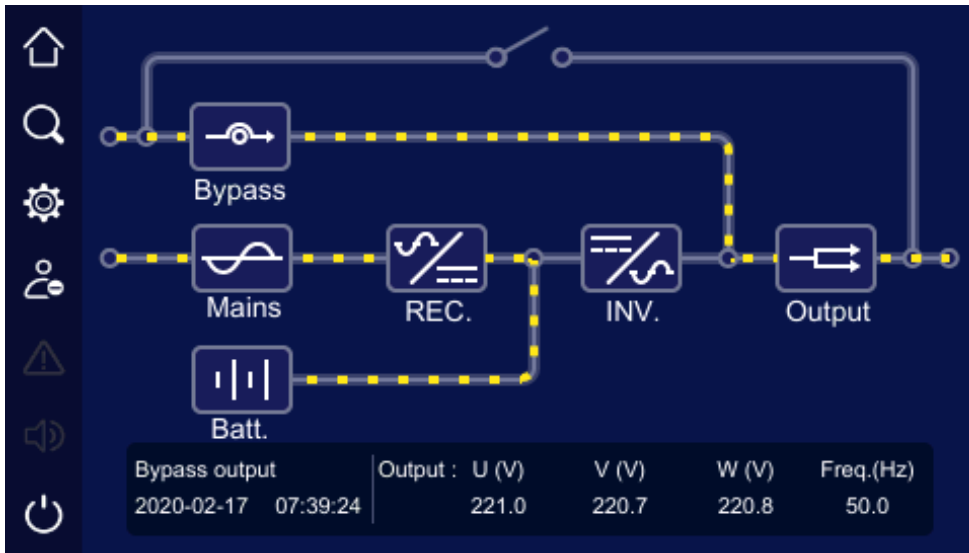

Figure5-6 Bypass output status

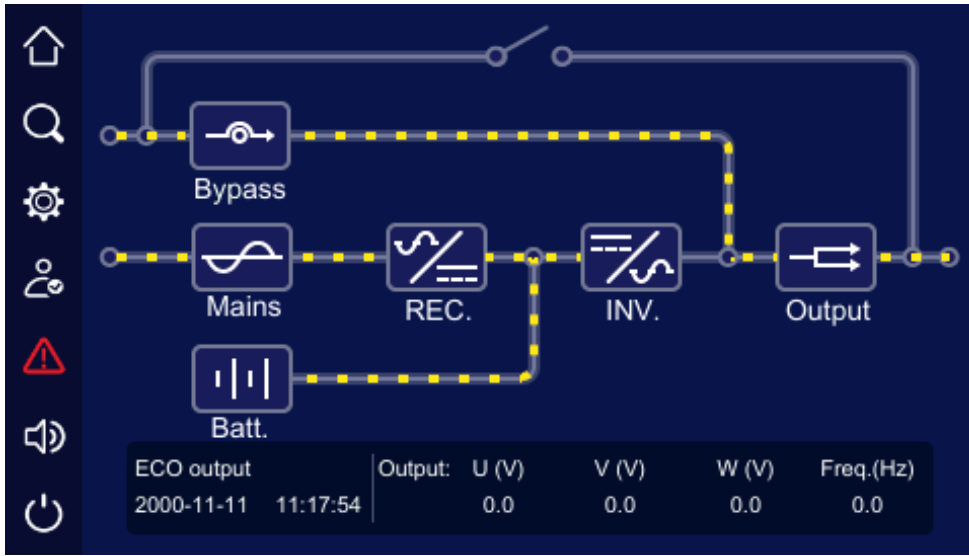

Figure5-7 ECO status

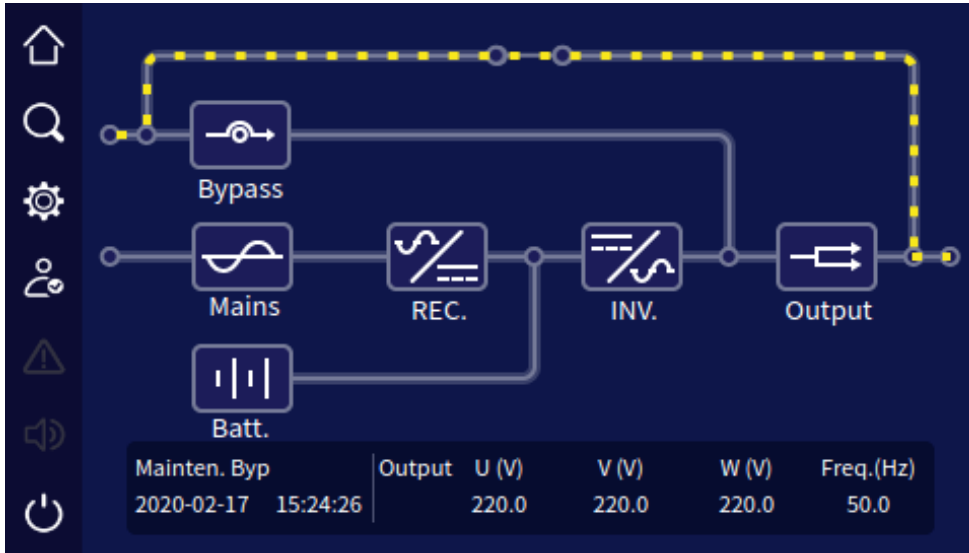



Figure5-8 Maintenance bypass output status

5.2.3 Bypass Information Page

On main page, click "  " icon, it will enter the bypass information page, as shown in Figure5-9.

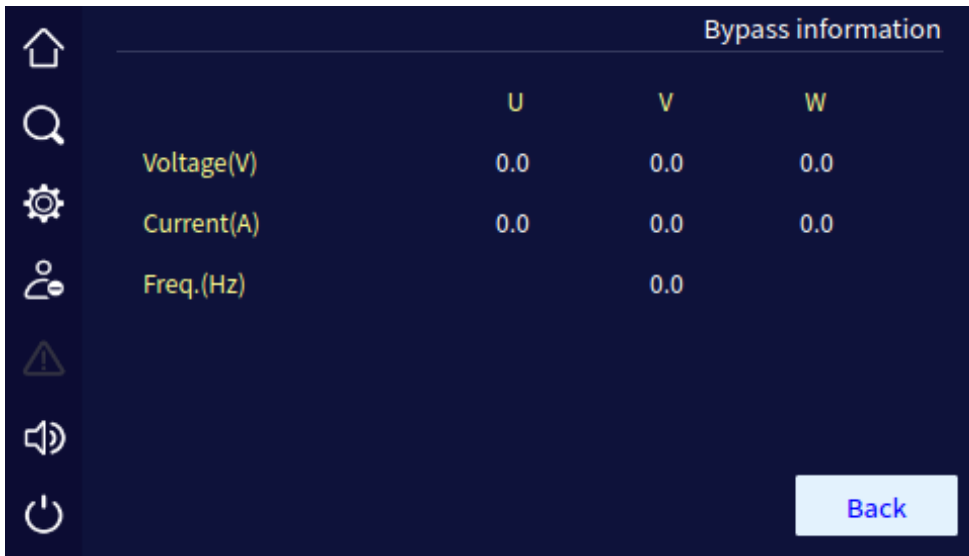



Figure5-9 Bypass information page

5.2.4 Mains Information Page

In the main page, click "  " icon, it will enter the mains information page, as shown in Figure5-10.

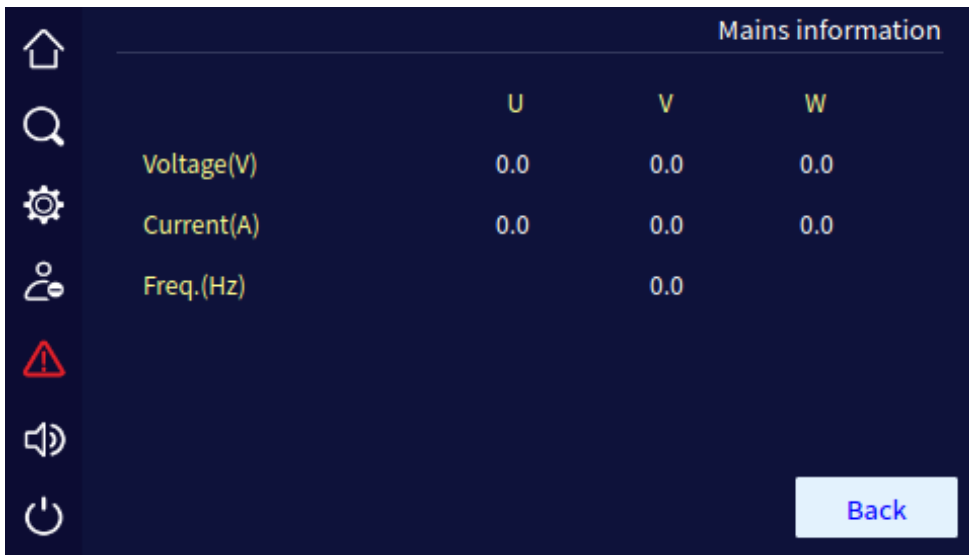



Figure5-10 Mains information page

5.2.5 Battery Information Page

In the main page, click "  " icon, it will enter the battery information page. When battery is discharging, it shows discharge current. When battery is equalizing charging or float charging, it will show charge current. The battery status shows the current battery status: discharge, equalized charge,

floating charge. Besides, the page also includes the battery remaining time capacity and remaining time, etc. as shown in Figure5-11.

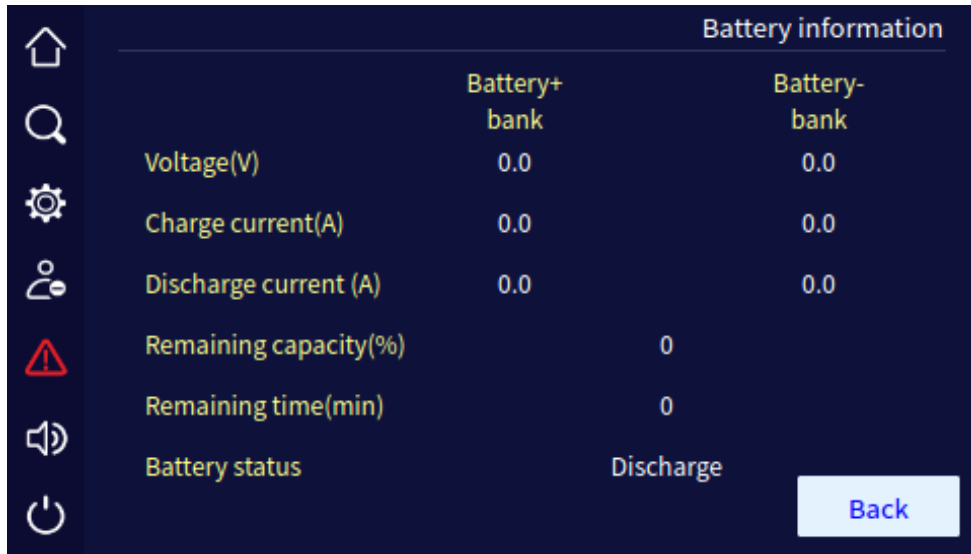



Figure5-11 Battery information page

5.2.6 Output Information Page

In the main page, click "  " icon, it will enter the output information page. The page shows the output voltage, current, load, active power, apparent power, power factor, output frequency, etc. as shown in Figure5-12.

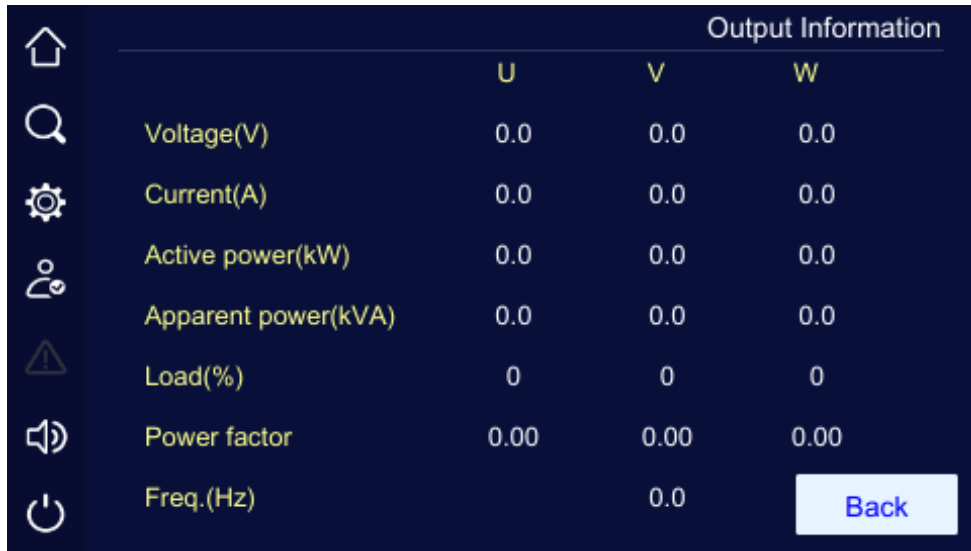



Figure5-12 Output information page

5.3 Login Page

In the main page, click "  " icon, it will enter the login page, as shown in Figure5-13. Only login, the setting management can be done.

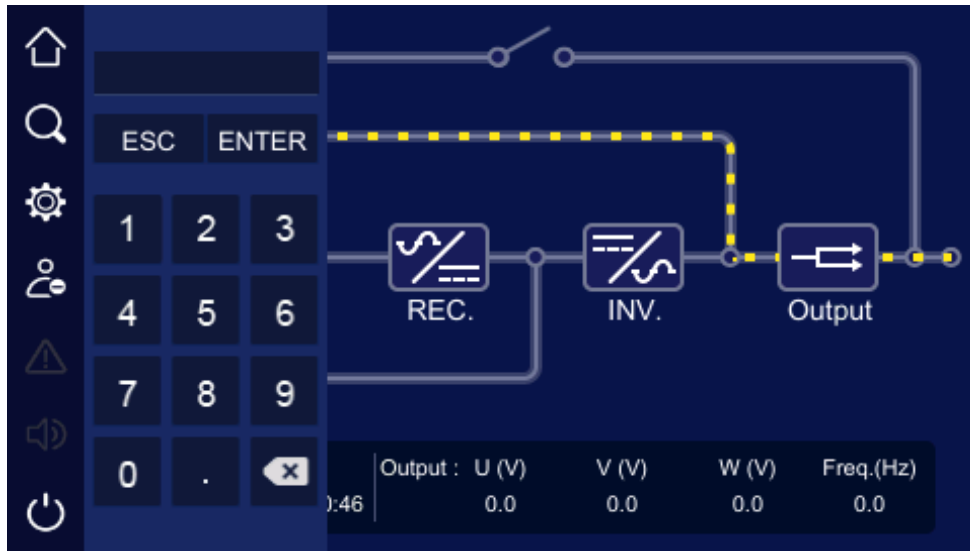



Figure5-13 Login page

NOTE

The password for common user is 111, the password for administrator is 222. Common user can check the parameters only, administrator can check and set the UPS parameters.

5.4 Information Management Page

In the main page, click "  " icon, it will enter the information management page, as shown in Figure5-14. The page includes run info, history record, user log and device config.

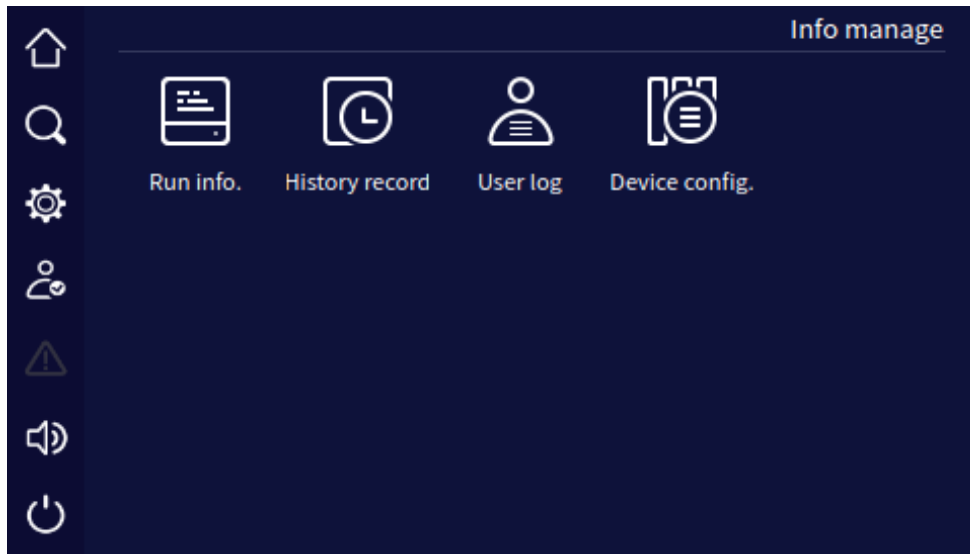

Figure5-14 Information management page

5.4.1 Run Information Page

In the information management page, click the run info icon, it will enter the run information page, as shown in Figure5-15 to Figure5-18. The page shows the UPS current status, including mains status, bypass status, battery status, output status, load status, rectifier status, inverter status, work mode, input loop, bypass loop, battery loop, fan status, inner temperature.

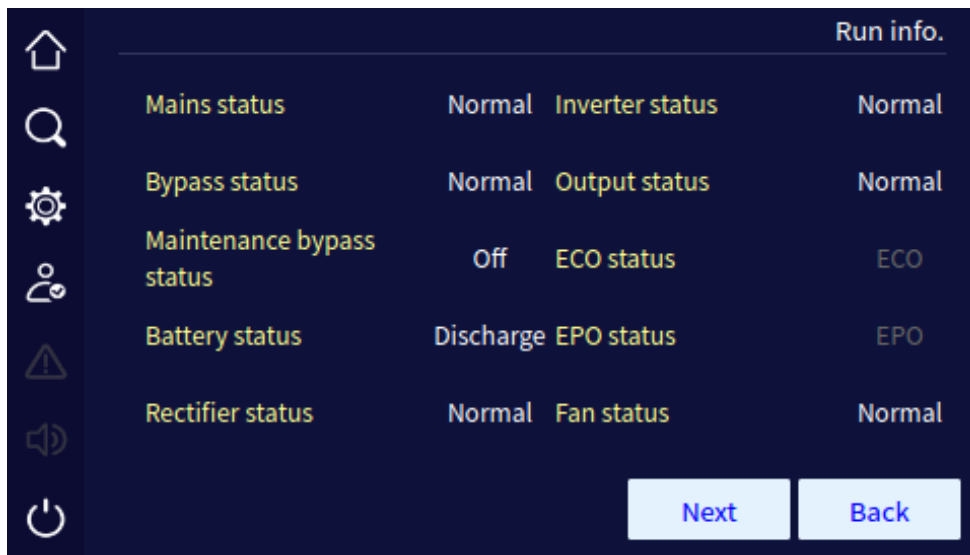

Figure5-15 Run info page 1 (single UPS)

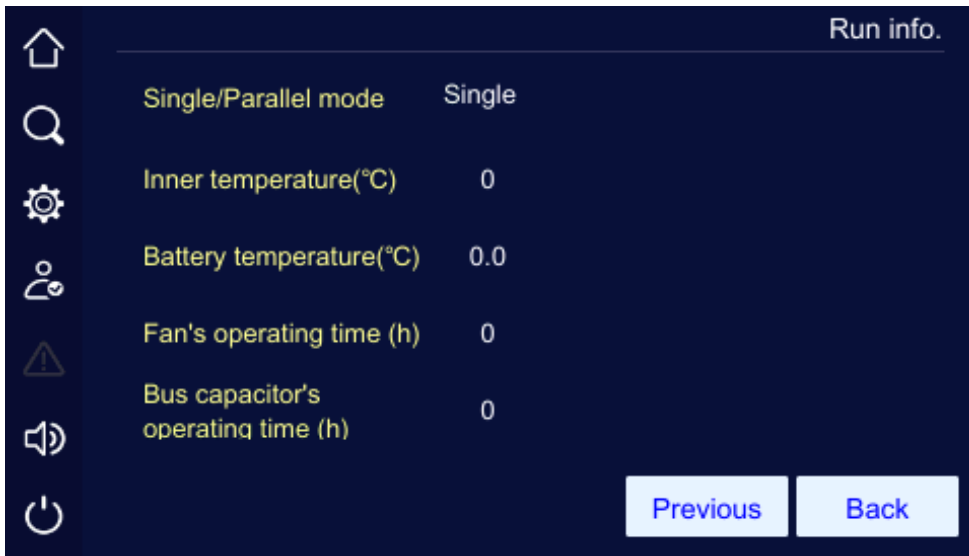

Figure5-16 Working status page 2 (single UPS)

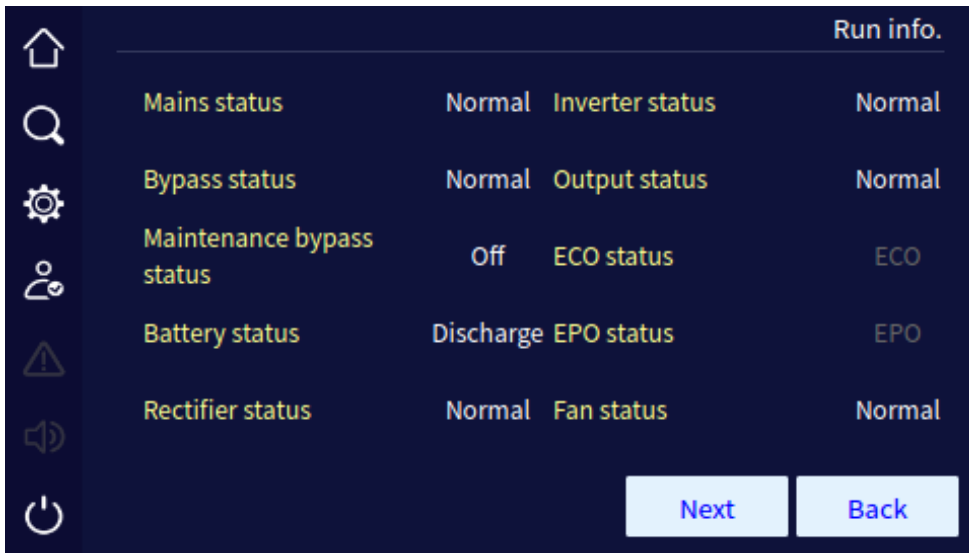

Figure5-17 Working status page 1 (parallel UPS)

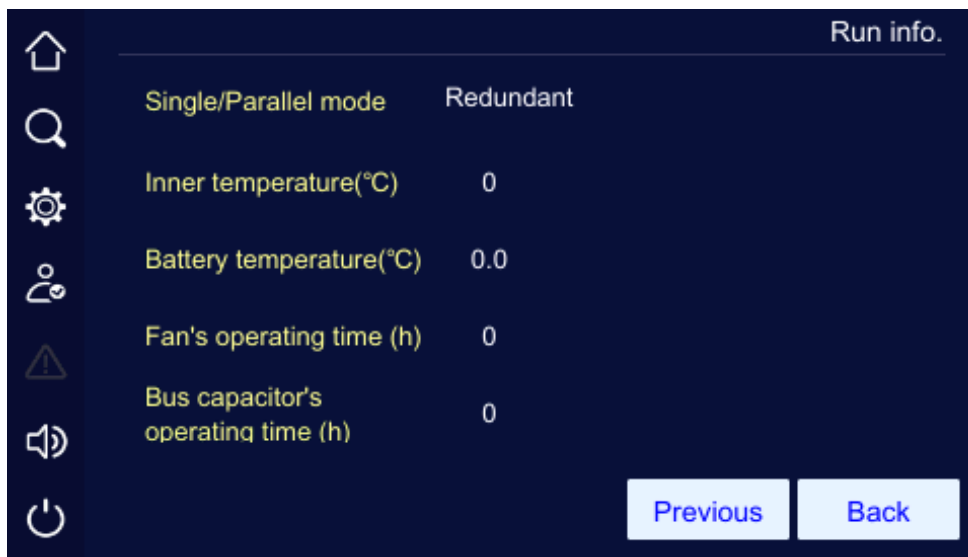

Figure5-18 Working status page 2 (parallel UPS)

5.4.2 History Record Page

In the information management page, click event log icon, it will enter the history record page, as shown in Figure5-19. The page shows the fault and alarm information, and they are listed on the basis of time. The first record is the latest fault.

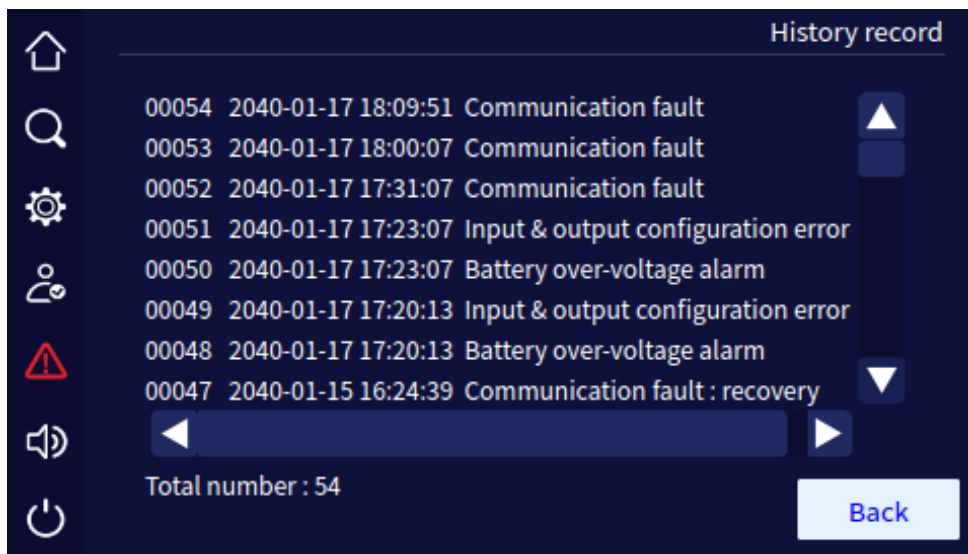

Figure5-19 Event log page

5.4.3 User Log Page

In the information management page, click the user log icon, it will enter the user log page, as shown in Figure5-20. The page shows the operation records, such as ON\OFF operation, mains voltage

range setting, bypass voltage setting, etc. The user log is listed on the basis of time. The first record is the latest operation record.

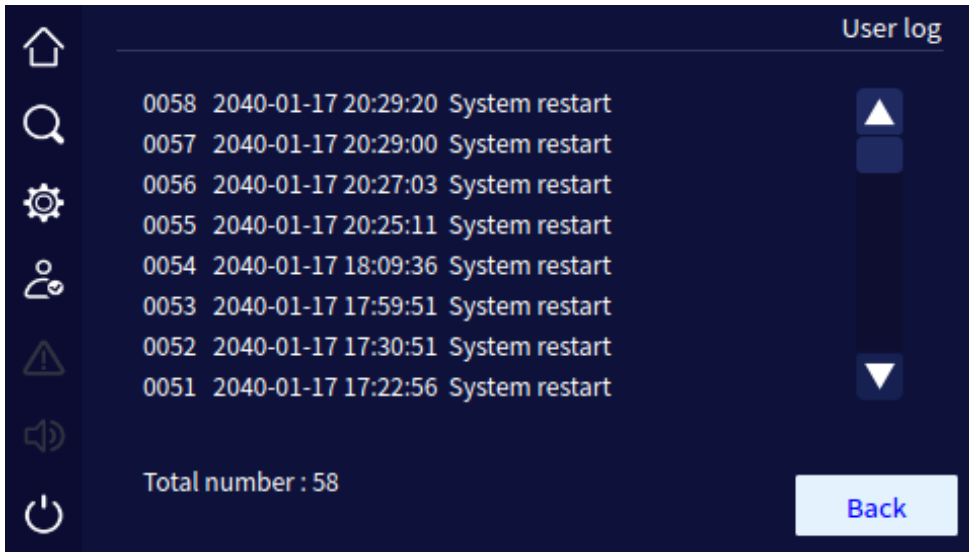

Figure5-20 User log page

5.4.4 Device Information Page

In the information management page, click the device information icon, it will enter the device information page, as shown in Figure5-21 and Figure5-22. Device information page includes product name and model, version information includes serial number, rectifier version, inverter version, system version, protocol version and HMI software version, etc.

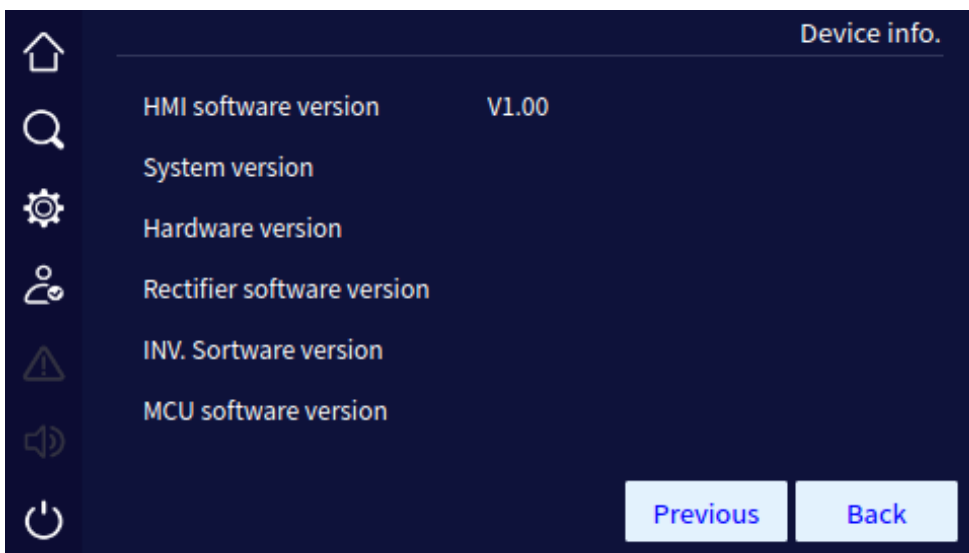

Figure5-21 Device information page 1

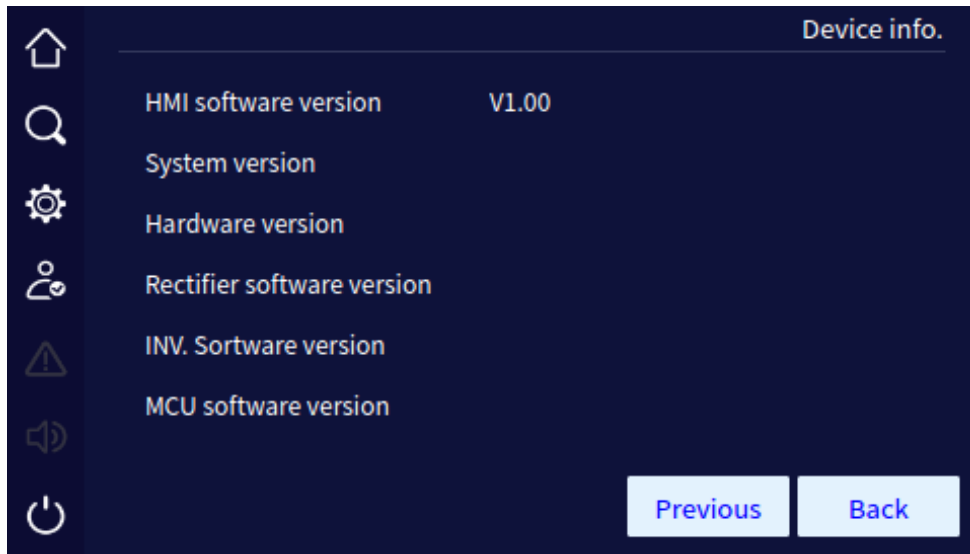



Figure5-22 Device information page 2

5.5 Setting Management Page

In the main page, after login, click "  " icon, it will enter the setting management page, as shown in Figure5-23. The page includes: system manage, battery manage, battery test, log manage, communication setting, screen setting, dedust setting and password setting.

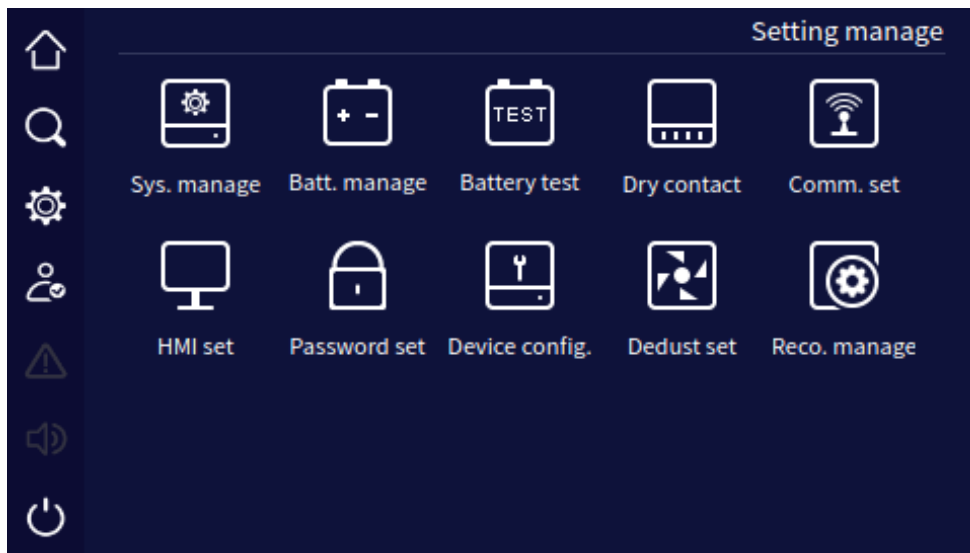

Figure5-23 Setting management page

5.5.1 System Manage Page

In the system manage page, user can set the mains voltage range, bypass voltage range, bypass frequency range, ECO mode and ECO voltage range, as shown in Figure5-24 to Figure5-26.

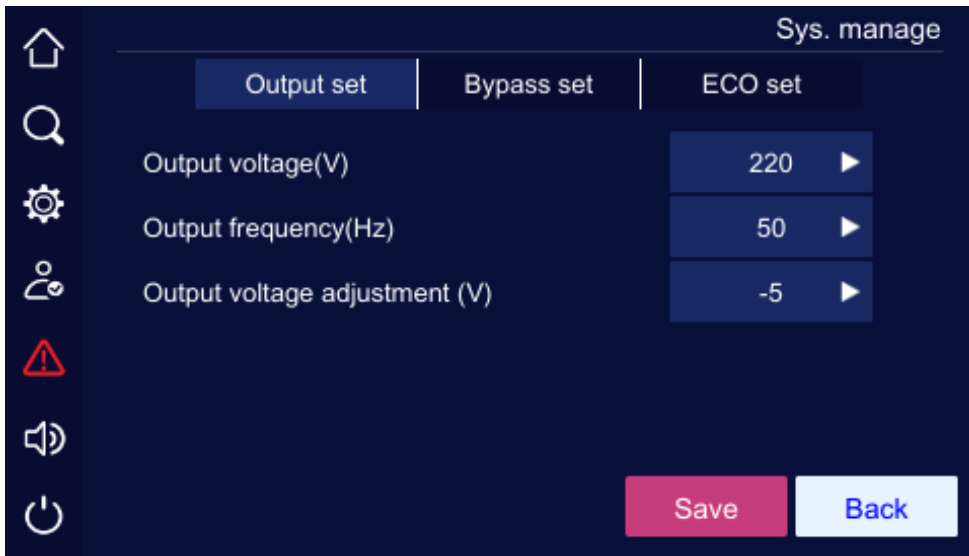

Figure5-24 System manage page 1 of output set

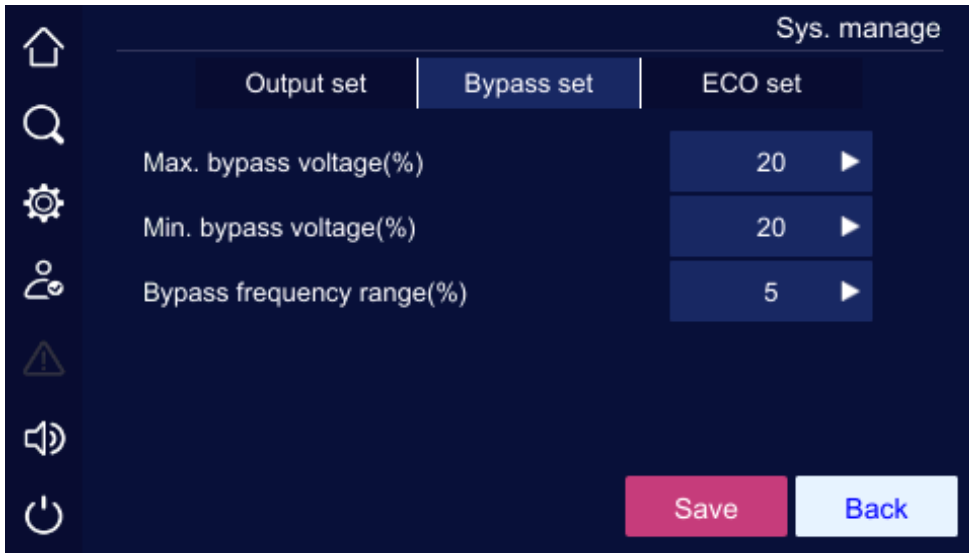





Figure5-25 System manage page 2 of bypass set



Figure5-26 System management page 3 of ECO set

Table5-1 Setting description for system mange

Item	Settable value
Output voltage (V)	220V, 230V, 240V
Output frequency (Hz)	50Hz, 60Hz
Output voltage adjustment (V)	-5~ +5
Max. bypass voltage (%)	10%, 15%, 20%
Min. bypass voltage (%)	10%, 15%, 20%
Bypass frequency range (%)	5%, 10%
ECO mode	On, Off
ECO voltage range (%)	10%, 15%
ECO frequency range (%)	5%, 10%

After changing the parameter, it is necessary to click "  " button to save the setting. If the setting is successful, there will be a "  " icon at the right side of the parameter, as shown in Figure5-27, if the setting is unsuccessful, there will be a "  " icon at the right side of the parameter, as shown in Figure5-28.

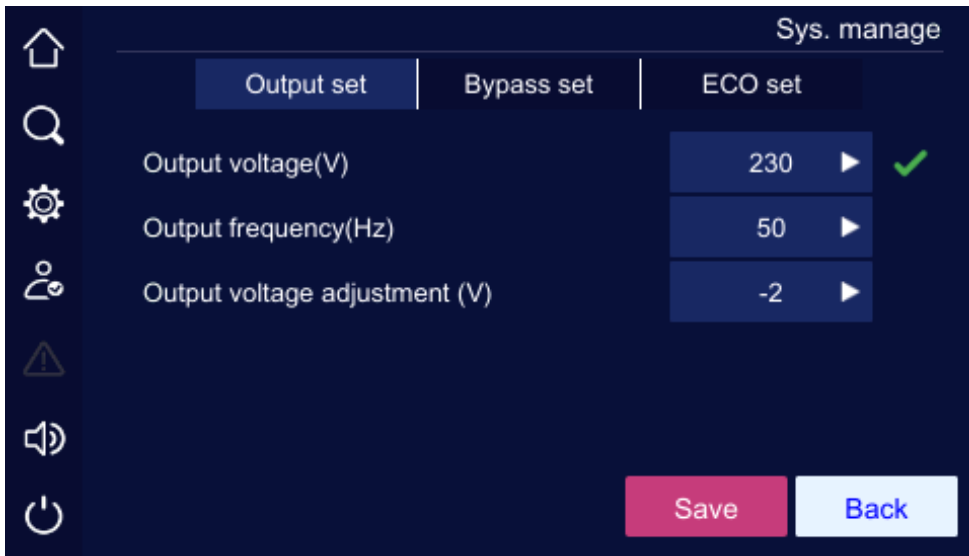

Figure5-27 Successful setting



Figure5-28 Unsuccessful setting

5.5.2 Battery Management Page

Battery manage page includes equalizing charge voltage, floating charge voltage, charge current, battery test ending voltage, low-voltage warning, low-voltage protection, temperature compensation coefficient, force equalizing charge. The battery manage page are as shown in Figure5-29 to Figure5-32.



Figure5-29 Battery set page 1 of battery management

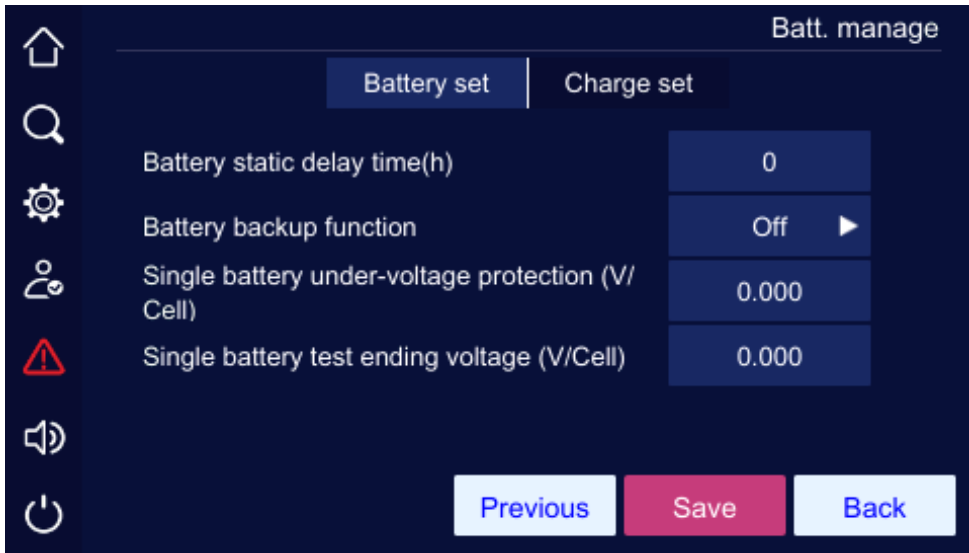

Figure5-30 Battery set page 2 of battery management

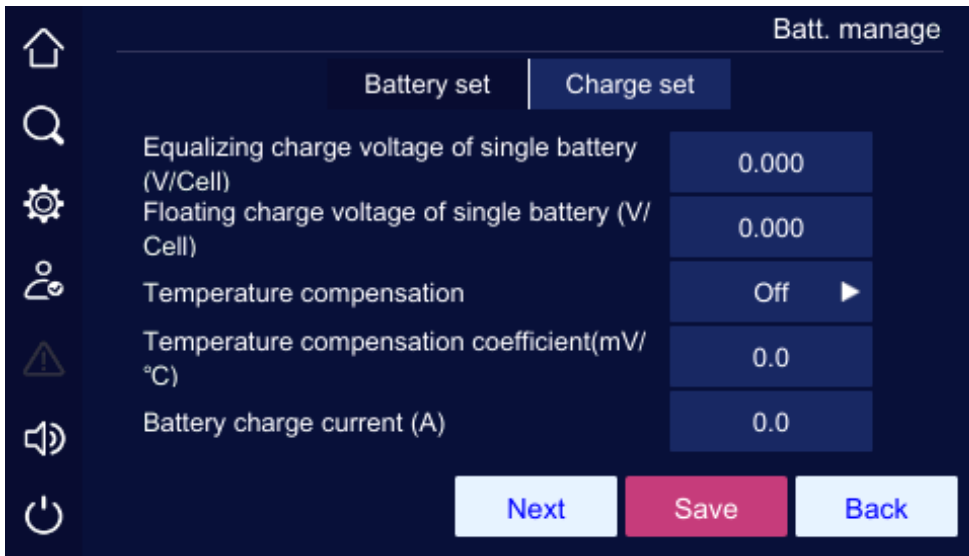

Figure5-31 Charge set page 1 of battery management

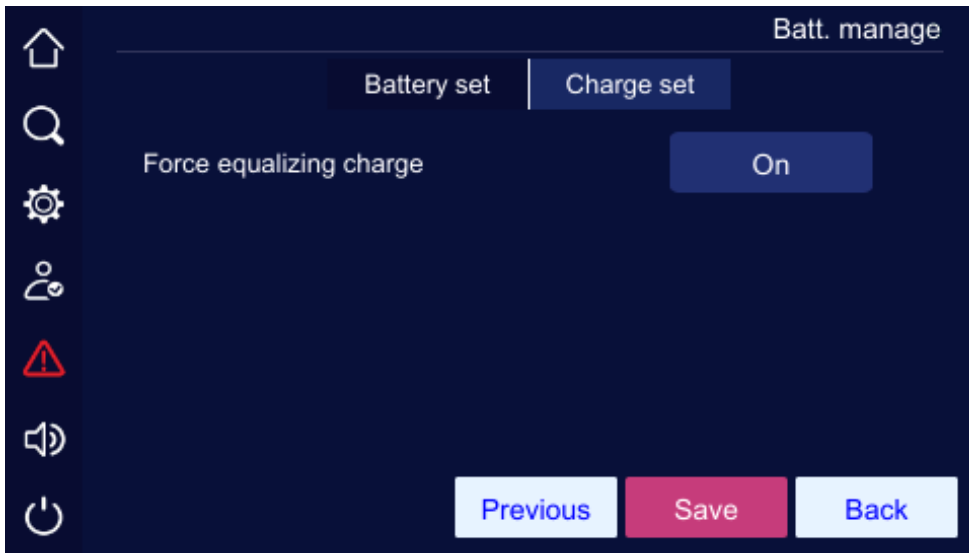



Figure5-32 Charge set page 2 of battery management

Table5-2 Setting description for battery manage page

Item	Settable value
Battery type	Lead-acid
Battery capacity (Ah)	1~2000
Battery amount (Cell)	48-120
Battery static function	On, Off

Item	Settable value
Battery static time (day)	1~30
Battery static delay time (h)	1~48
Battery backup function	On, Off
Single battery low-voltage protection (V/Cell)	1.667~1.867
Single battery test ending voltage (V/Cell)	1.667~1.867
Equalizing charge voltage of single battery (V/Cell)	2.083~2.417
Floating charge voltage of single battery (V/Cell)	2.083~2.333
Temperature compensation	On, Off
Temperature compensation coefficient (mV/°C)	0~5.0
Battery charge current (A)	10kVA-20kVA: 1.0~10.0; 30kVA-40kVA: 1.0~20.0
Force equalizing charge	On

Click number input box, it will display the input range of setting value at the top of the input keyboard. When the setting exceeds the range, the setting will be invalid. After setting, click "" button to save the setting. Successful setting/unsuccessful setting mark is the same as that of system management.

5.5.3 Battery Test Page

Battery test includes standard test and depth test and the battery test also can be canceled. The page shows the test status, battery current, consumed capacity and test time. The battery test page is as shown in Figure5-33.

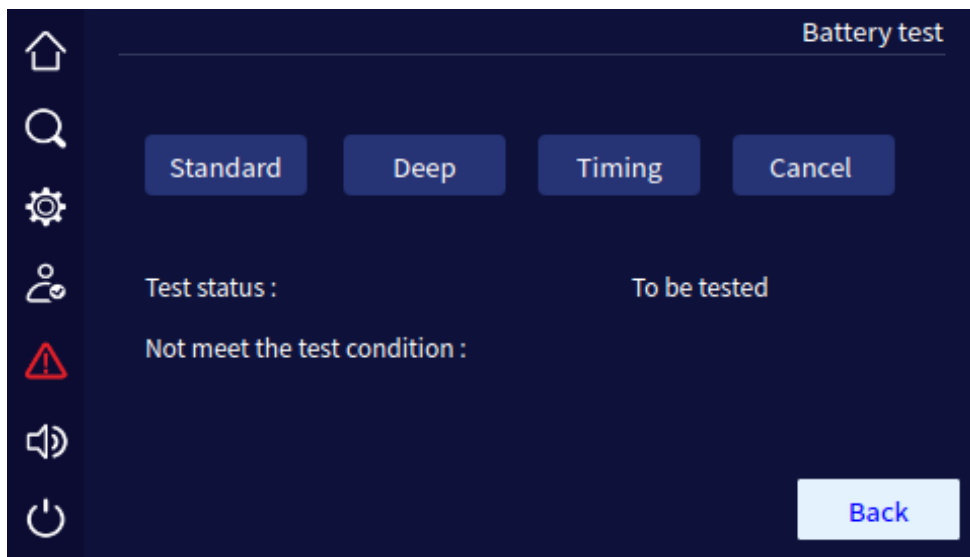

Figure5-33 Battery test page

5.5.4 Dry Contact Page (Reserved)

In setting manage page, click Dry Contact icon, it will enter dry contact setting page, as shown in Figure5-34 and Figure5-37.

NOTE

The dry contact setting is the same, below we take dry contact 1 as an example to illustrate.

Input dry contact

On Dry contact page, click "**Charge forbidden**" icon, it will enter corresponding dry contact setting page, as shown in Figure5-35. Click "**OK**" button to save the dry contact setting and return Dry contact setting page. After setting, click "**Save**" button on Dry contact page to save the setting. Successful setting/unsuccessful setting mark is the same as that of system management.

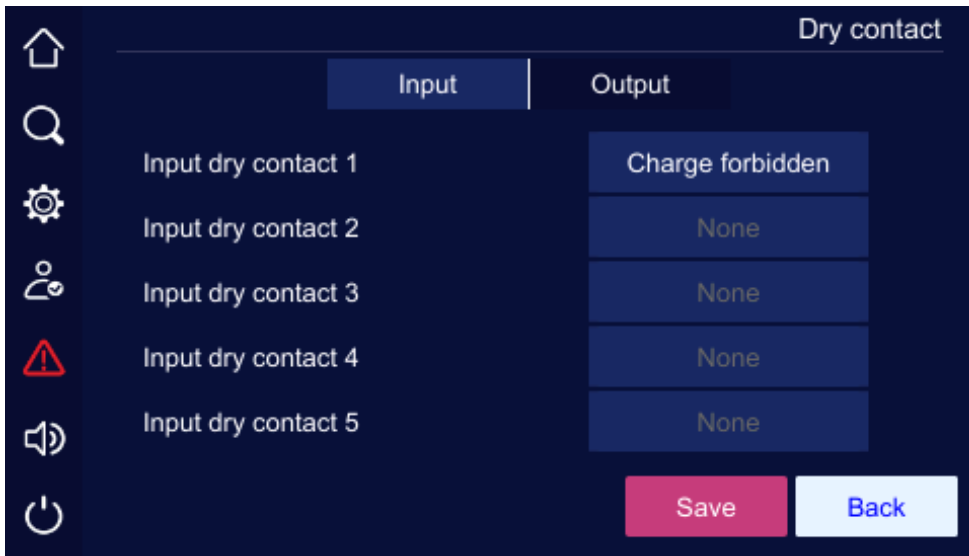

Figure5-34 Input dry contact setting page 1

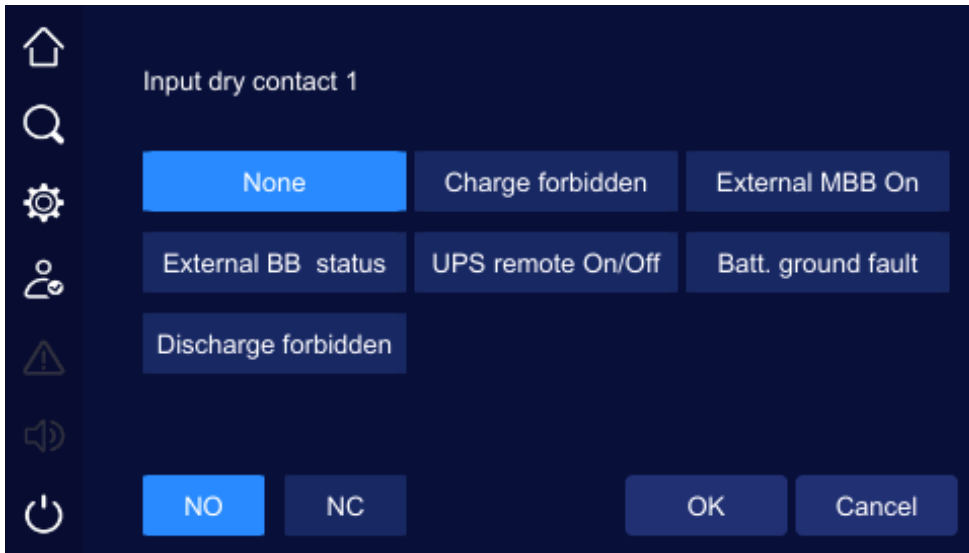

Figure5-35 Input dry contact setting page 2

Output dry contact

On Dry contact page, click "ECO output" icon, it will enter corresponding dry contact setting page, as shown in Figure5-37. Click "OK" button to save the dry contact setting and return Dry contact setting page. After setting, click "Save" button on Dry contact page to save the setting. Successful setting/unsuccessful setting mark is the same as that of system management.

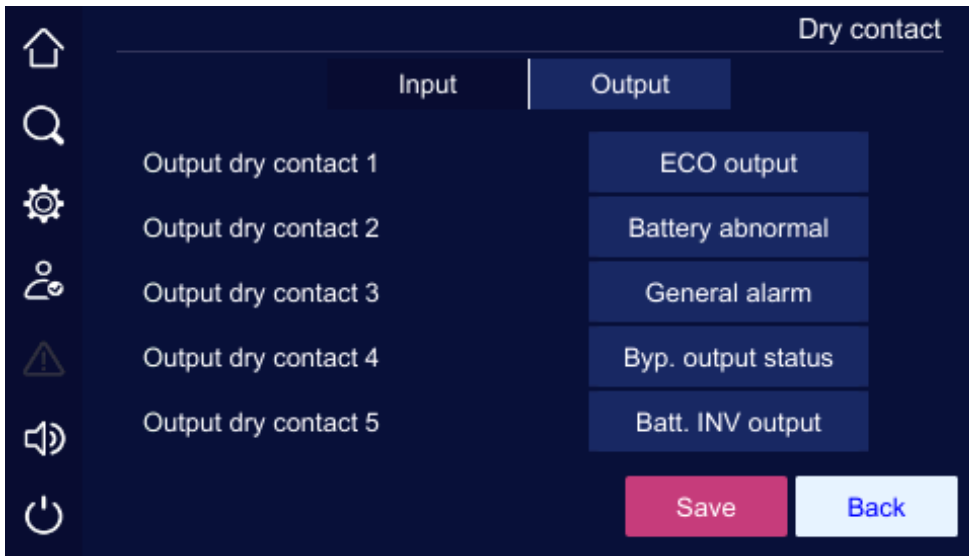

Figure5-36 Output dry contact setting page 1

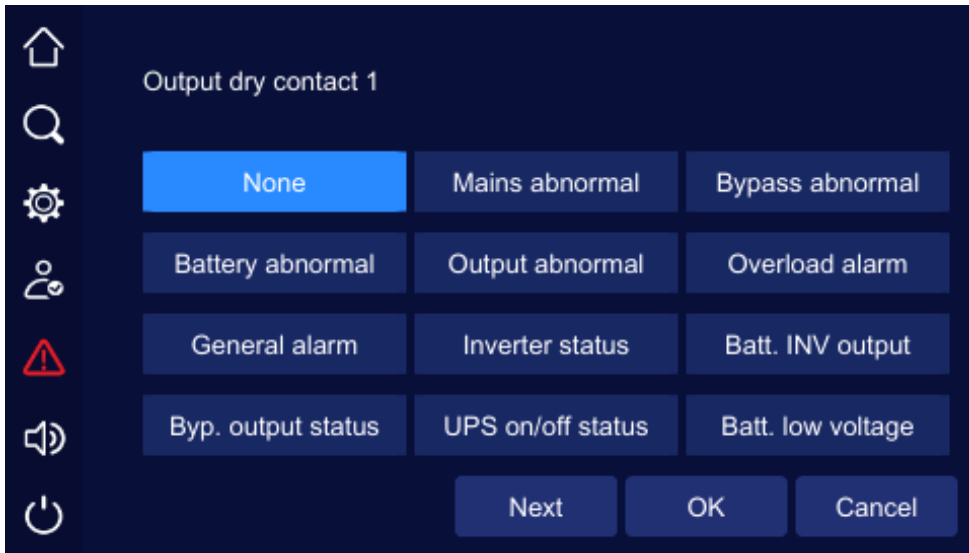

Figure5-37 Output dry contact setting page 2

5.5.5 Communicaiton Setting Page

User can select the communication way of upper-computer in communication setting page, Modbus and SNMP can be set. For Modbus communication, user can set the Modbus address and baud rate. The communication setting page is as shown in Figure5-38.

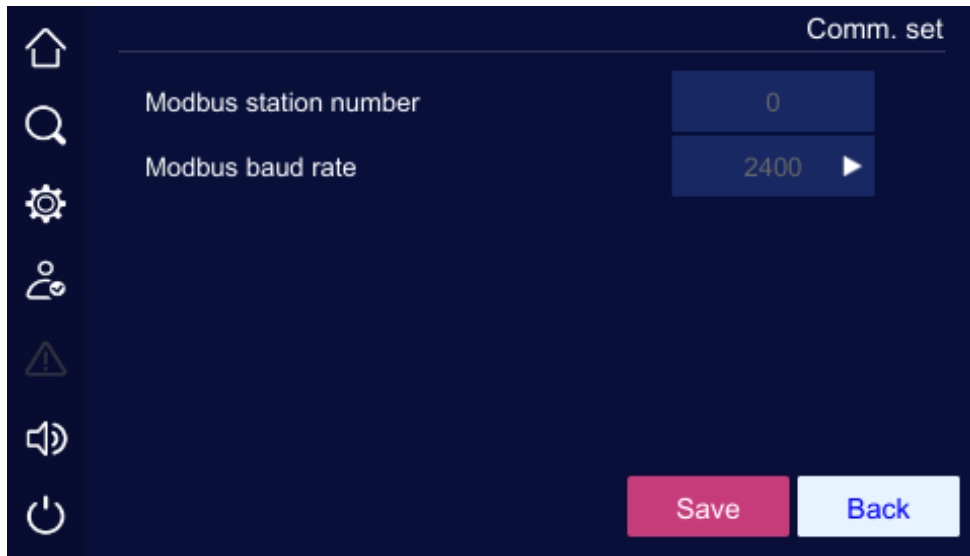

Figure5-38 Communication setting page

5.5.6 HMI Setting Page

In screen setting page, user can set the date, time, language, backlight and screen saver, as shown in Figure5-39.



Figure5-39 Screen setting page

5.5.7 Password Setting Page

In setting management page, click password setting icon, it will enter the password setting page, as shown in Figure5-40.

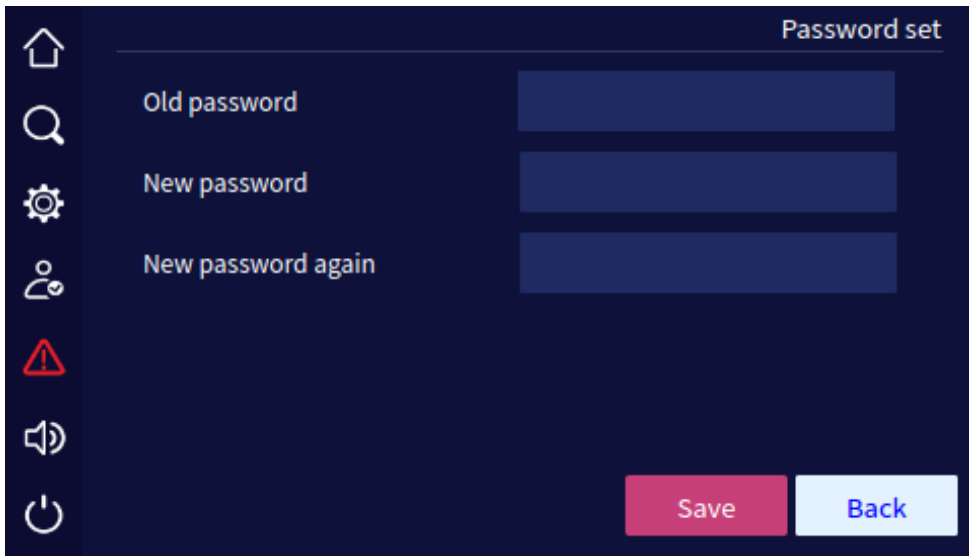

Figure5-40 Password setting page

5.5.8 Device Configuration Page

In setting manage page, click Device config icon, it will enter Device configuration page, as shown in Figure5-41 to Figure5-44.

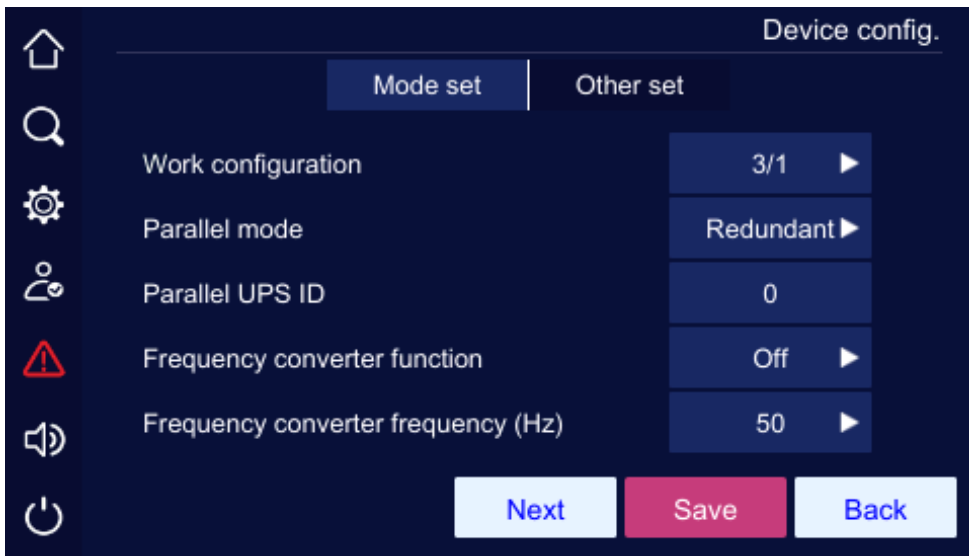

Figure5-41 Mode set page 1 of device configuration

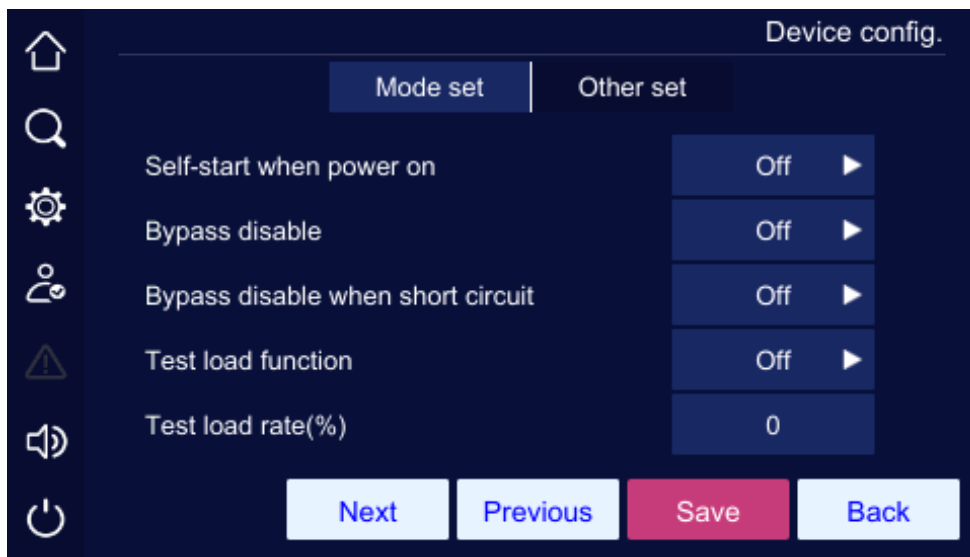

Figure5-42 Mode set page 2 of device configuration

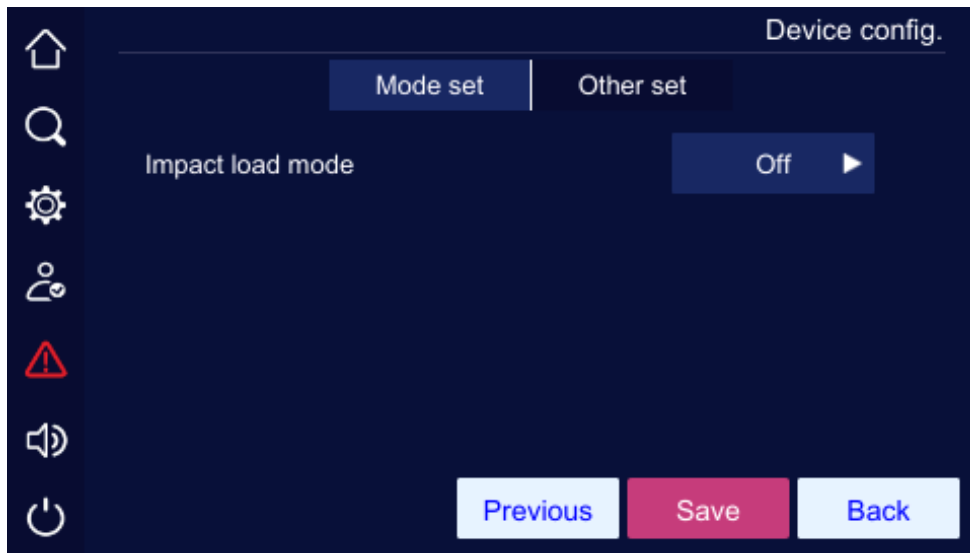

Figure5-43 Mode set page 3 of device configuration

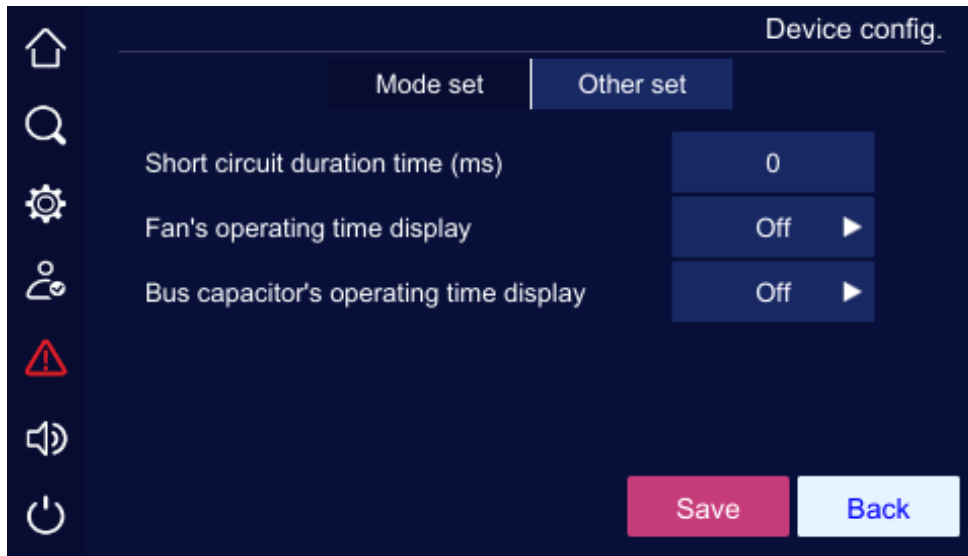



Figure5-44 Other set page of device configuration

Table5-3 Setting description for battery mange page

Item	Settable value
Short circuit duration time (ms)	10-200
Fan's operating time display	On, Off
Bus capacitor's operating time display	On, Off
Work configuration	10kVA-20kVA: 3/3, 3/1, 1/1; 30kVA-40kVA: 3/3, 3/1
Parallel mode	Redundant, Single, Expand, BSC
Parallel UPS ID	1-4
Frequency converter function	On, Off
Frequency converter frequency	50, 60
Self-start when power on	UPS will not turn off, On, Off
Bypass disable	On, Off
Bypass disable when short circuit	On, Off
Test load function	On, Off
Test load rate (%)	10-100

Item	Settable value
Impact load mode	On, Off

Click number input box, it will display the input range of setting value at the top of the input keyboard. When the setting exceeds the range, the setting will be invalid. After setting, click "  " button to save the setting. Successful setting/unsuccessful setting mark is the same as that of system management.

5.5.9 Dedust Setting Page

In setting manage page, click Batt. Manage icon, it will enter battery manage page, as shown in Figure5-45.

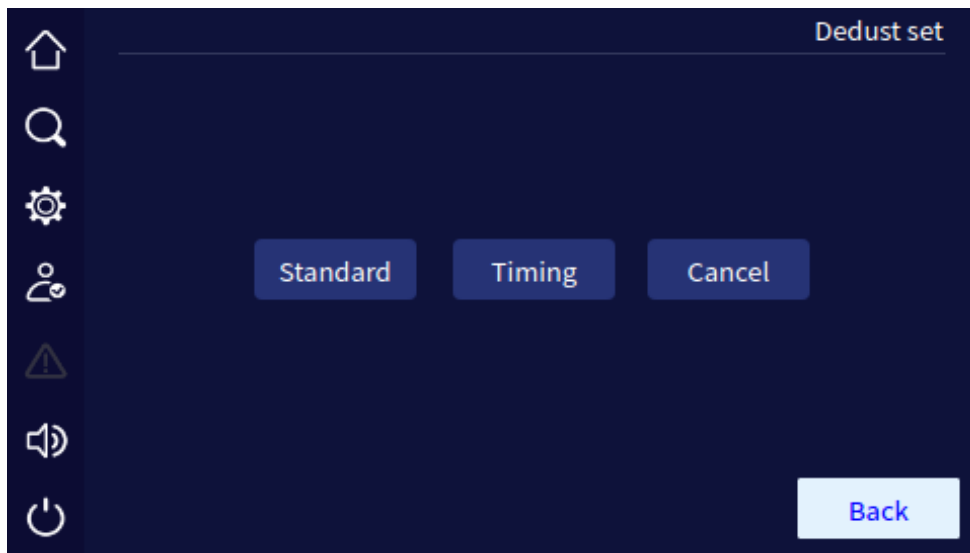



Figure5-45 Dedust set page

5.5.10 Record Manage Page

Reco. mange page can export and clear the history log, user log, and wave capture. Click "  " button, you can export the selected items by USB flash drive, click the "  " button, you can clear the selected items. Before clearing, it will show the prompting window to confirm, as shown in Figure5-46.

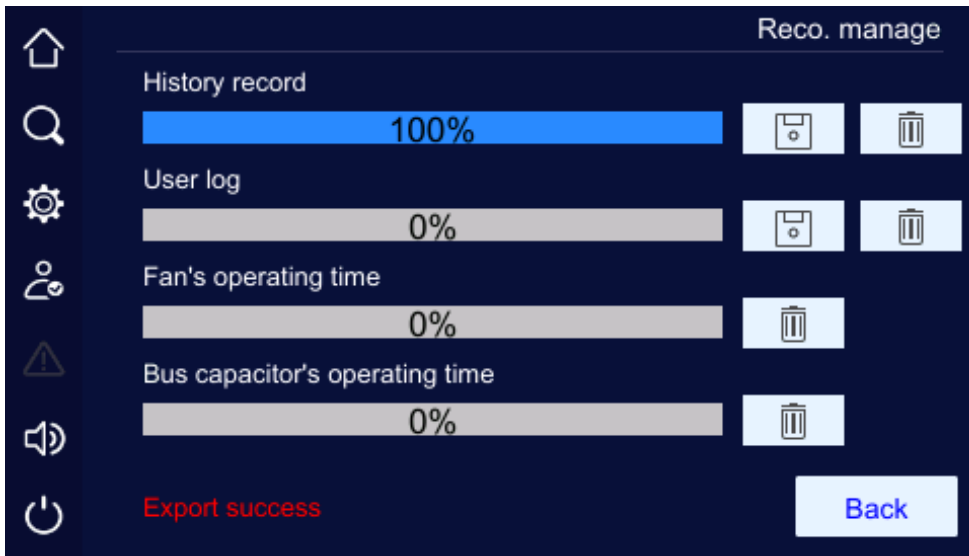

Figure5-46 Export success of record manage page

Insert U dish, you can backup the records, as shown in Figure5-47 and Figure5-48.

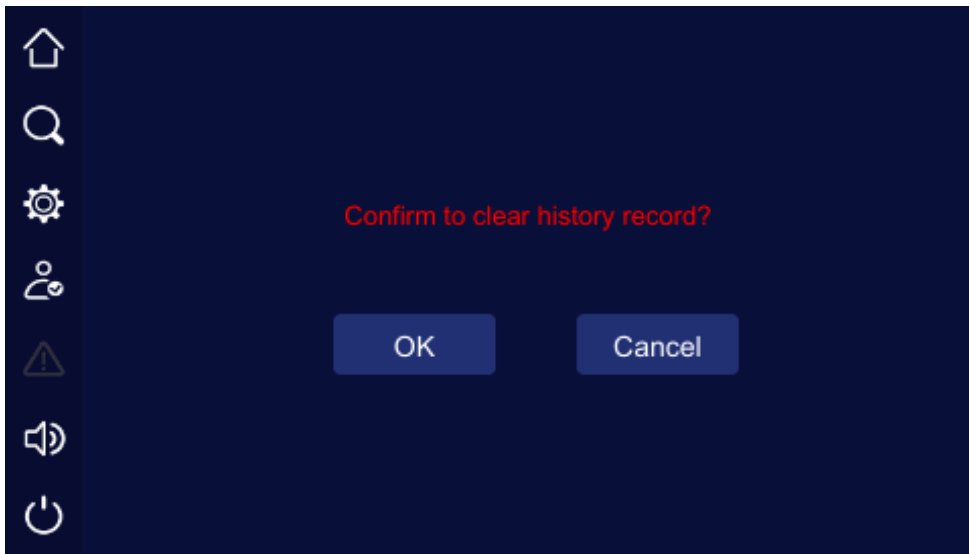

Figure5-47 Prompting for clearing log

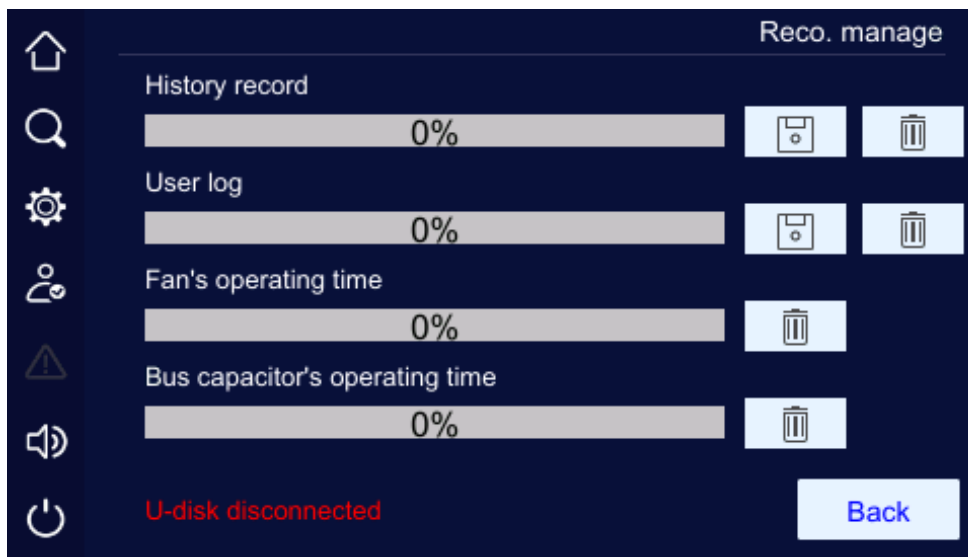

Figure5-48 The U dish is not inserted

5.6 Current Fault Page

When the UPS is fault, the "⚠" icon at the left will light on, as shown in Figure5-49. Click it, the page will show the current fault information, as shown in Figure5-50.

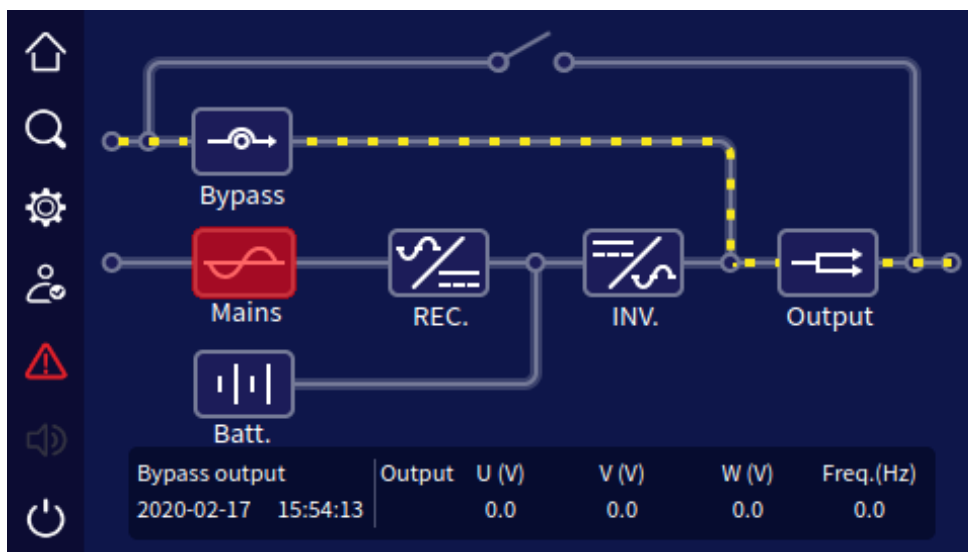

Figure5-49 Fault alarm status

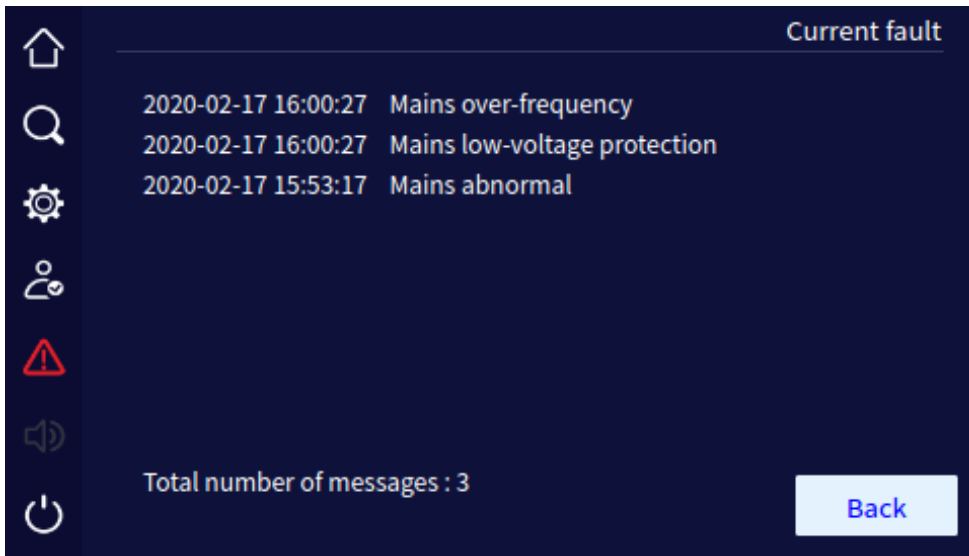

Figure5-50 Current fault information

5.7 Buzzer Control

When the UPS fault, the buzzer icon will light on. Click the "🔊" icon, the buzzer can be muted or opened. Figure5-51 shows the buzzer mute status.

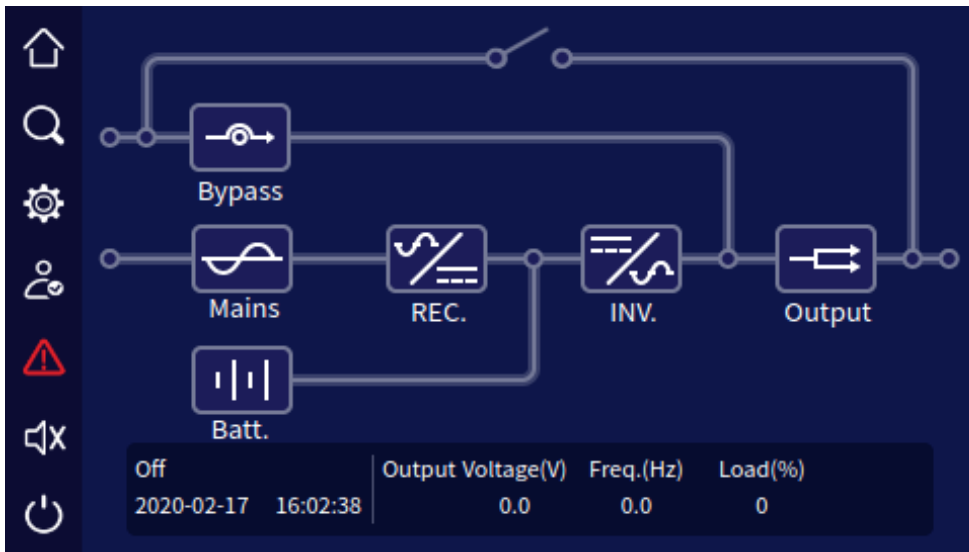



Figure5-51 Buzzer mute status

NOTE

The buzzer cannot be muted when it long beep.

5.8 ON\OFF Operation

In main page, click "  " icon, the UPS can be started or shutdown. When the UPS is shutdown, click the icon, it will show “confirm to power on?”, when the UPS is started, it will show “confirm to power off?” as shown in Figure5-52 and Figure5-53.

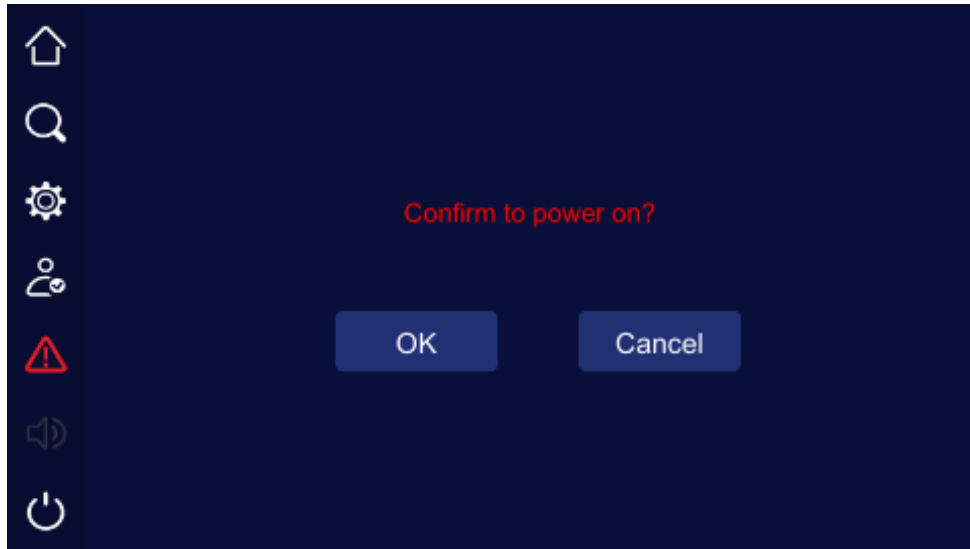

Figure5-52 Confirm to turn on page

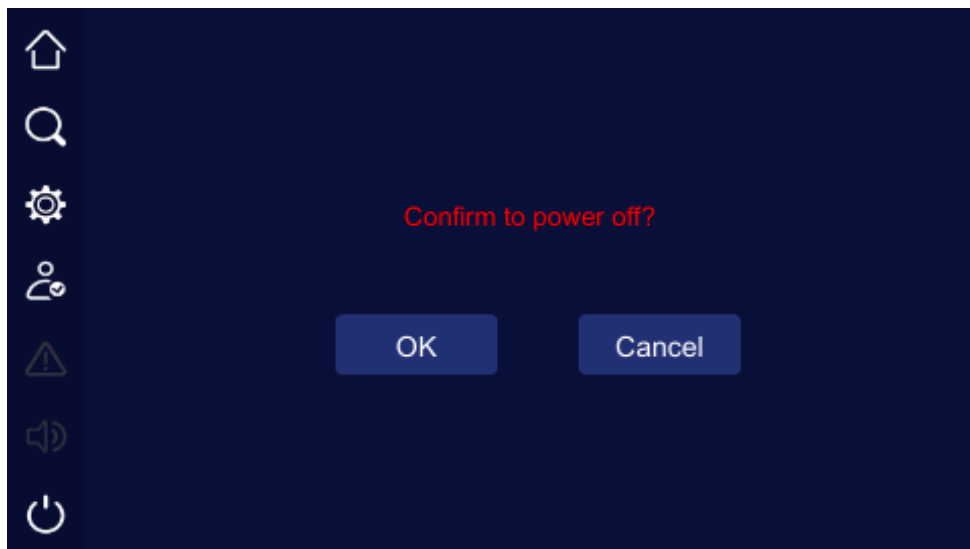

Figure5-53 Confirm to turn off page

6 Use and Operation

This chapter mainly describes the operation process, operation method, daily maintenance and troubleshooting, etc.

6.1 Check Before Startup

- Check if the wire connection is firm and the color of AC wires is in accordance with the specification.
- Check if UPS is grounded reliably.
- Check if the voltage between the neutral wire and grounding wire is less than 5Vac.
- If the UPS equipped with remote monitoring device, check if the wiring of the RS485 port is correct.
- If it is long backup model, check if the wiring between UPS and battery box is correct and reliable.
- Check if the wiring is neat and the wire binding is in accordance with the specification.
- Check if the installation and wiring are good for transformation, expansion and maintenance in future.
- Check that there is no short-circuit in the output of the UPS and the load capacity isn't beyond the rated capacity of the UPS.

6.2 Startup Operation

Step 1 Switch on the external mains, bypass and battery switch.

Step 2 After LCD/touch screen light on, press the "□" and "▼" button (LCD) for 2s at the same time or "ON" combination button (touch screen) for 1s at the same time on the front panel to start the UPS.

Step 3 About 10s later, if the UPS works steadily, start loads, such as PC, etc.

**CAUTION**

Start load according to "high power device → small power device", which is to avoid overload protection when starting high power device.

----End

6.3 Shutdown Operation

- Step 1 Close load and keep the UPS running without load for about 10min to exhaust heat.
- Step 2 Press "□" and "▲" button (LCD) for 2s at the same time or "OFF" combination button (touch screen) for 1s at the same time on the front panel to shut down the UPS.
- Step 3 Switch off the external battery, bypass and mains switch.

----End

6.4 Parallel System Operation

6.4.1 Start Parallel System

**CAUTION**

Ensure that each UPS in the parallel system is equipped with the parallel kit (optional) for parallel and has been set to the same parallel mode through the screen display.

Please refer to the 4.5.2 Function Setting of LCD screen or 5.5.8 Device Configuration Page of touch screen for corresponding screen display settings.

Before completely starting the parallel system, please do not start load, and ensure that all switches of UPS are off.

The following steps for start the parallel system:

- Step 1 Ensure that each UPS of parallel system is installed properly, start each UPS of parallel system according to the 6.2 Startup Operation one by one.
- Step 2 After each UPS in parallel system outputs by inverter, measure the inverter voltage of each paralleled UPS. The voltage difference between max. and min. voltage should be within 8V. Close the output

breaker of paralleled UPS, measure the circulating current of parallel UPS, and the current should be less than 3A.

When the voltage different larger than 8V, measure the output voltage of the UPS and check if the output are all 220V, if the voltage different larger than 15V, please report it to our company to maintain it. In addition, once the circulating current of parallel UPS too large, it will lead to the inverter fault. If the circulating current is larger than 3A, please report it to our company to maintain it.

Step 3 Switch on the total output breaker of UPS, each output branch breaker, and then start the load one by one.

----End

6.4.2 Shut Down Parallel System

Generally, it isn't recommended to start or close parallel system frequently.

Step 1 Shut down all load.

Step 2 Shut down parallel UPS one by one.

Step 3 Switch off the related breakers of each UPS (when daily use, the breakers can be not closed).

----End

6.4.3 Exit Parallel System

When one UPS in parallel system fault, it will exit from parallel system automatically with sound & light alarm. At that time, perform the operations shown in Figure6-1, the fault UPS will be exited from parallel system completely to achieve online hot maintenance or replacement.

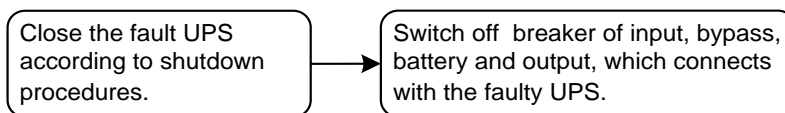

Figure6-1 Exit parallel system



CAUTION

When the parallel system works normally, it's better not to exit the output from parallel system before the UPS closed, or the power system will be abnormal.

6.4.4 Redundance Function of Parallel System

When system adopts N+1 redundance design, the total output cannot larger than N times of single UPS's rated power. When one paralleled UPS fault, it can put into use or exit parallel system and do not affect the operation of system, which enhance the system reliability. When output exceed N times of single UPS's rated power, the overload UPS (exceeding $N/(N+1)$ times of single UPS's rated power) will send alarm. For example, for the backup system with two UPS, once one UPS overload for 50% rated power, it will send overload alarm.

6.5 Periodic Preventative Maintenance

To improve the efficiency and reliability of the UPS, perform the following maintenance regularly:

- Clean the UPS by dry cloth regularly. Don't use liquid or spray cleaner. Before cleaning, shut down the UPS.
- Check if the wiring of input and output is firmly and well connected.
- Check the working status of cooling fans regularly. Prevent sundries from blocking the air outlet. If damaged, please replace it in time.
- Check the battery voltage and the working status of UPS regularly to discover fault timely.

6.6 Battery Maintenance

The working life of battery is based on the environment temperature and discharge times. Using battery in the high temperature for a long time or discharging battery deeply will reduce the working life of battery.

When selecting battery box, please pay attention to following items:

- Charge the battery for 10 hours before using. During charging, the UPS still can be used, but if power outage at the same time, the discharging time may be less than the standard backup time.
- Generally, charge and discharge the battery once every 4 to 6 months. Discharge the battery till under-voltage and power off and then charge it. In high temperature area, charge and discharge the battery once every 2 months. The charging time for the standard battery should be more than 10 hours every time.
- If the UPS hasn't been used for a long time, it is recommended to charge the battery more than 10 hours every three months.

- Generally, the working life of battery is 3 to 5 years. If battery is not so good, replace it in time. The battery replacement should be performed by authorized professional.

6.7 Troubleshooting

6.7.1 Common Fault

As shown in Table6-1, it only includes some common fault diagnosis. If any doubt, contact the local office or distributor for details.

Table6-1 Troubleshooting

Fault phenomenon	Possible reason
The mains normal, after starting the UPS, it outputs normally, but it works in the battery mode and the buzzer beeps intermittently.	<p>Check if the contactors and wiring terminals in the input circuit are in good condition;</p> <p>Check if the displayed input voltage amplitude or frequency of mains on the LCD/touch screen is beyond the allowable range of UPS;</p> <p>Check if the mains input breaker is disconnected, if yes, please close the breaker again.</p>
After installing UPS, connecting with power will fuse the fuse or cause tripping operation.	The wiring of UPS input or output is short circuit.
After starting, the LCD/touch screen display and output are normal. But once connecting with load, it will stop outputting immediately.	<p>UPS is overload seriously or the output circuit is short-circuit. Please reduce load to proper capacity or find the short-circuit reason. The common reason is that the output changeover socket short-circuit or the input short-circuit after UPS damage;</p> <p>The load is not started according to "high power device → small power device". Restart the UPS, and after the UPS works steadily, start high power load first, and then start small power ones successively.</p>
Buzzer long beeps, fault indicator lights on, UPS works in bypass mode and inverter failure.	The output is overload. The load is too heavy and beyond the rated power of the UPS. Please reduce load or select a UPS with larger power capacity. If it is temporary bypass caused by impact of load start and recovers automatically, it still is

Fault phenomenon	Possible reason
	normal; UPS over-temperature protection. Check if the air inlet and air outlet of UPS is blocked or the working temperature of UPS is beyond the allowable range.
Usually, UPS works normally. When power failure, it doesn't transfer to battery mode or it transfers to battery mode and battery under-voltage protection soon.	Battery aging, the battery capacity loss. Please replace battery; Battery charger fault. At ordinary time, the battery cannot be charged; Battery wire doesn't connect well or the terminals contact is bad.
When the load is PC, everything works normally. When power failure, UPS works normally, but the computer system halted.	The grounding connection is not so good. The floating voltage between the neutral wire and the grounding wire is too high.

Table6-2 Meaning of fault symbol and buzzer status

NO.	Fault symbol	Buzzer status	Meaning
1	EPO	Long beep	UPS has emergency protection (if equipped with EPO function), Bypass output and inverting output are all closed.
2	Mode fault	Long beep	UPS system mode system settings and the actual wiring do not match the fault, please check the main power or bypass wiring, and make the actual system is consistent with the set mode system.
3	Maintain bypass fault	Long beep	UPS maintenance bypass protection, inverted output closed, please checks back board maintenance bypass detection port is shorted.
4	Output fault	Long beep	The UPS output is faulty, detect the UPS output is short or over load.
5	Mode mismatch	Long beep	The UPS of the input and output mode in the parallel does not match the actual system.

NO.	Fault symbol	Buzzer status	Meaning
6	Voltage mismatch	Long beep	The UPS of the output voltage in the parallel does not match the actual system.
7	Frequency mismatch	Long beep	The UPS of the frequency in the parallel does not match the actual system.
8	Bypass mismatch	Long beep	The UPS of the bypass voltage or frequency in the parallel does not match the actual system.
9	Pattern mismatch	Long beep	The UPS parallel mode setting in the parallel system does not match the actual system.
10	Power mismatch	Long beep	The UPS of the output power setting in the parallel does not match the actual system.
11	Battery number mismatch	Long beep	The UPS of the battery number setting in the parallel does not match the actual system.
12	Parallel mismatch	Long beep	The UPS of parameters setting in the parallel does not match the actual system.
13	Short mismatch	Long beep	The UPS of short turn to bypass setting in the parallel does not match the actual system.
14	Two-ended fault	Long beep	Fall-off fault at both ends of the parallel wire.
15	Single-ended fault	Slow beep	Fall-off fault at one ends of the parallel wire.
16	Auxiliary power supply failure	Long beep	UPS internal working power failure, if it cannot be automatically recovered, please report repair promptly.
17	Fan failure	Urgent beep (alarm once about every 0.2s)	Fan fault warning prompt, please check the fan for damage or blocking.
18	CAN fault	Slow beep (alarm once about every	The CAN communication of parallel system abnormal, please check if the parallel wire is damaged or there is only one UPS in parallel

NO.	Fault symbol	Buzzer status	Meaning
		2.0s)	system works.
19	SCI fault	Long beep	UPS internal communication abnormal, if the continuous alarm cannot be restored, please report repair promptly.
20	There is no redundancy in the parallel UPS	Slow beep (alarm once about every 2.0s)	The total output load of the UPS parallel system exceeds the full load of the single machine, check that the output load exceeds the requirements for redundant backups.
21	Main power abnormal	Long beep	The mains power input phase sequence is abnormal, please check the main power input wiring.
		3 continuous alarms at 10s intervals	The main power input occur lack N fault, power down failure, overvoltage protection, under voltage protection, over-frequency fault, under-frequency fault, please check whether the main power input status is normal.
22	Bypass abnormal	Slow beep (alarm once about every 2.0s)	At mains status, the bypass voltage abnormal, frequency abnormal, phase sequence abnormal, or mode setting mismatches the wiring. Please check if the bypass breaker is closed, if the bypass phase sequence is normal, if the wiring way of bypass matches the system mode setting.
23	Battery abnormal	Slow beep (alarm once about every 2.0s)	Battery has been pressure protection, charging fuse failure, over-pressure alarm fault, please check the battery status is normal.
		Urgent beep (alarm once about every 0.2s)	Battery wiring fault, charging short, under-voltage protection, under-voltage warning problem, please check the battery wiring and the current state is normal.

NO.	Fault symbol	Buzzer status	Meaning
		No buzzer warning	The battery charging temperature is too high.
24	Rectifier abnormal	Urgent beep (alarm once about every 0.2s)	UPS rectifier fault.
25	Inverter abnormal	Long beep	UPS inverter fault.

**NOTE**

The buzzer alarm in the table above describes the phenomenon of UPS boot state and no beep ban when the buzzer is not set, the shutdown state or some abnormal phenomena when setting the buzzer ban will prompt the information in the LCD/touch screen, but the buzzer alarm will not be issued.

7 Package, Transportation and Storage

7.1 Package

During packing, please pay attention to the place direction requirements. At the side of the package, there is afraid of wet, handle with care, upward, stack layer limit, etc. alarm marks. And also, the device model is printed on the package. At front of the package, the device name is printed.

7.2 Transportation

During transporting, pay attention to the warning marks and avoid severe impact on the package. Place the device according to the marked direction, which is to avoid damage the component. Any inflammable, explosive, corrosive object is not allowed to shipping with the device. While midway transportation, do not put the device in the open air. The device cannot suffer any rain, snow or liquid material or mechanical damage.

7.3 Storage

During storing, place the UPS according to the marked direction. The package box should be far away from ground for 200mm, and keep at least 500mm from wall, eat source, cold source, window or air inlet.

Storage temperature: -20~50°C, relative humidity is 20%~80%. In the warehouse, any inflammable, explosive, corrosive object or harmful gas is not allowed, and also, strong mechanical shake, impact or magnetic field is forbidden. The storage period of these requirements, generally, is 6 months. If the UPS is stored more than 6 months, it is necessary to check again. If the UPS is stored for a long time, please charge the battery every 3 months.

A Technical Specifications

Index		Model	MY10/10	MY15/15	MY20/20	MY30/30	MY40/40
			S/10T	S/15T	S/20T	S/30T	S/40T
Input	Input mode	1W+N+PE (can be set to 3W+N+PE)			3W+N+PE		
	Voltage range (Vac)	When the input voltage in the range of 176~280, the UPS can bear load of 100% rated power; When the input voltage in the range of 80-176, the output of the UPS needs to decrease rated power linearly to use					
	Frequency range (Hz)	39.5~70.5					
	Bypass synchronism track range (Hz)	50/60±10% (50/60 self-adaption)					
	Bypass input voltage range (Vac)	220/230/240±20% (phase voltage) (default is 220)					
	Input power factor	≥0.99					
	Input THDI	Resistive full load: ≤3%; non-linear full load: ≤5%					
	Battery voltage (Vdc)	MY15/15S/15T~40/40S/40T: ±144~±240 (can be selected from ±72 cells~±120 cells, default is ±96 cells, when the battery voltage is set from ±72 cells~±90 cells, the output of the UPS decreases to 75% rated) (single battery voltage is 2Vdc); MY10/10S/10T: ±96~±240 (can be selected from ±48 cells~±120 cells, default is ±48 cells)					
	Charge current (A)	1~10 settable (default is 1)				1~20 settable (default is	

Index	Model	MY10/10 S/10T	MY15/15 S/15T	MY20/20 S/20T	MY30/30 S/30T	MY40/40 S/40T
						2)
Output	Output mode	3W +N+PE (can be set to 1W+N+PE)				
	Capacity (kVA/kW)	10/10	15/15	20/20	30/30	40/40
	Voltage (Vac)	L-N: 220/230/240 (default is 220); L-L: 380/400/415 (default is 380)				
	Frequency (Hz)	When mains is normal, it tracks the bypass input frequency; When mains is abnormal, it tracks the frequency of 50±0.1 or 60±0.1 (default is 50)				
	Wave form	Sine-wave				
	Voltage distortion	Resistive full load: ≤2%; non-linear full load: ≤4%			Resistive full load: ≤1%; non-linear full load: ≤4%	
	Power factor	0.9/1 settable (default is 1)				
	Transfer time of bypass and inverter (ms)	Synchronization: <1ms; asynchronization: <10ms				
	System efficiency	Up to 96%				
	Overload capacity	PF=0.9 Inverter: <105%: continue; 115%~130%: 15min; 130%~155%: 1min; 155%~200%: 200ms; >200%: protection immediately. Bypass: <130%: continue; 130%~155%: 1min;				

Index		Model	MY10/10	MY15/15	MY20/20	MY30/30	MY40/40
			S/10T	S/15T	S/20T	S/30T	S/40T
		>155%: 200ms PF=1.0 Inverter: <105%: continue; 105%~110%: 60min; 110%~130%: 10min; 130%~155%: 1min; 155%~200%: 200ms; >200%: protection immediately. Bypass: <130%: continue; 130%~155%: 1min; >155%: 200ms					
Other	DC startup function	Equipped					
	Panel display	LCD/touch screen show the running status of the UPS					
	Communication port	RS485/RS232/SNMP					
	Alarm function	Alarm for battery low-voltage, mains abnormal, UPS fault, output overload, etc.					
	Protection function	Protection for battery under-voltage, overload, short-circuit, over-temperature, input over-voltage, communication abnormal, etc.					
	Noise (dB)	<55 (25°C)					
	Work temperature (°C)	-5~40					
	Relative humidity	0~95%, non-condensation					
	Size (W×D×H) (mm ³)	308×803×882				358×840×1250	

Index		Model	MY10/10	MY15/15	MY20/20	MY30/30	MY40/40
			S/10T	S/15T	S/20T	S/30T	S/40T
	Weight (kg)		MY10: 50; MY10S: 95; MY10T: 128	MY15: 50; MY15S: 133.5; MY15T: 128	MY20: 50; MY20S: 133.5; MY20T: 128	MY30: 88.5; MY30S: 254.6; MY30T: 222	MY40: 88.5; MY40S: 254.6; MY40T: 222

- Specifications are subject to change without prior notice.

B Acronyms and Abbreviations

A

AC Alternating Current

B

BMD Bypass Maintain Detection

BB Battery Breaker

D

DC Direct Current

E

ECO Economic Operation Model

EPO Emergency Power Off

L

LCD Liquid Crystal Display

M

MBB Maintenance Bypass Breaker

P

PE Protective Earthing

R

RS485 Recommend Standard485

S

SNMP Simple Network Management Protocol

U

UPS Uninterruptible Power System



KEHUA HENGSHENG CO., LTD.

4402-03163 001

ADD: No. 457, Malong Road, Torch High-Tech Industrial
Zone, Xiamen, Fujian, China(361000)
TEL: 0592-5160516(8 lines) FAX: 0592-5162166
Http: //www.kehua.com

Manufacturer: Zhangzhou Kehua Technology Co., Ltd.
ADD: Beidou Industrial Zone, Jinfeng Industrial District,
Zhangzhou, Fujian, China(363000)
TEL: 0596-2600000 2600886 FAX: 0596-2895827