

ESR5 safety relay

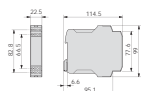



Description

Electronic safety relays 2

Ordering

ESR5 basic devices 3

Contact expansion modules 3

Technical data

Basic devices, contact expansion modules 4

Dimensions

Basic devices, contact expansion modules 7

Electronic safety relays

Basic devices

Description



Functional safety on machines – monitoring with safety relay ESR5

Eaton's new ESR5 safety relays provide optimal safety and an extremely high degree of reliability on plant and machinery. Applications that meet the highest safety requirements in accordance with EN ISO13849-1 up to PLe, in accordance with IEC62061 up to SILCL3 and in accordance with IEC61508 up to SIL3 can be realized with the ESR5 series of devices.

Functionality

Safety relays are intended to reliably monitor the signals from safety devices at all times and switch off quickly and reliably in an emergency. Single-channel and dual-channel versions are available for the construction of safety-orientated applications. The internal logic of the safety relay monitors the safety circuits (Emergency Stop, guard door...) and activates the enable paths in fault-free condition. Upon actuation of the safety device or in the event of a fault the enable paths are switched off in compliance with the stop category. Any faults that occur in the control circuit, such as a ground fault, cross connection fault or wire breakage are detected with certainty. Activation of the enable paths is prevented in the event of a fault.

Configuration

Universal use is achieved due to the extensive performance range and voltage range of the ESR5 safety relays. The electronic safety relay consists of the internal logic and two redundant relays with positively driven contacts for the enable and signalling paths. The wiring is effected simply on encoded plug-in terminals. If any servicing is performed, these ensure fault-free replacement of the modules without any additional wiring work.

Approvals

Safety relays ESR5 are approved according to:

- TÜV-Rheinland



- UL/CUL



Advantages at a glance

- Use for the highest safety requirements in accordance with EN ISO 13849-1, IEC 62061 and IEC 61508.
- Devices suitable for the world market thanks to certification from UL, CUL and TÜV Rheinland.
- Plug-in screw terminals for fast and fault-free replacement.
- Multi-voltage versions 24 - 230 V AC DC for a flexible range of application.



Emergency stop circuits

Allows the safe stopping of a hazardous movement, immediate stop for Stop category 0 and controlled stop Stop category 1 according to IEC 60204-1; for use in single or dual channel safety monitoring of emergency stop circuits.

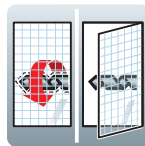

Guard door monitoring

Used with moving guards such as doors, barriers or flaps. Positions are reliably detected, monitored and enabled to safety-related requirements.

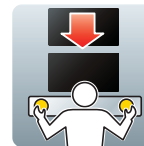

Safe operation with two-hand control

Type III to EN 574. Used for hazardous machine movement such as presses, punching, shearing. It allows the movement of dangerous operation only when both hands of the operator are outside the dangerous area and the two pushbuttons are operated within 0.5 seconds of each other.

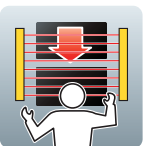

Electro-sensitive protective devices (ESPE)

Protection of the hazardous location or area in the vicinity of machines by means of contactless guards such as light grids/light curtains.

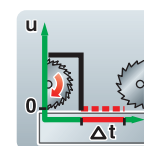

Off-delay circuit

Makes it possible to safely stop a hazardous movement with controlled stopping according to IEC 60204-1 stop category 1.

Ordering







ESR5

Actuating voltage	Suitable for	Number of enabling paths to IEC/EN 60204 Stop category	Signal contacts	Part no. Article no.	Price See price list	Std. pack
U _c		0	1			

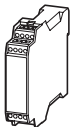

ESR5 electronic safety relays

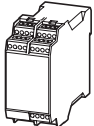

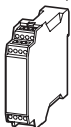

Safety relays for Emergency-Stop and guard door monitoring

	Single-channel 24 V DC, 24 V AC, 50/60 Hz	Cat. 2 according to EN 954-1 PL d according to EN ISO 13849-1 SILCL 3 according to IEC 62061 SIL 3 according to IEC 61508 Cat. 4/PL e possible only with the aid of fault exclusions.	4	–	1	ESR5-NO-41-24VAC-DC 118701	1 off 
	dual channel 24 V DC, 24 V AC, 50/60 Hz	Cat. 4 according to EN 954-1 PL e according to EN ISO 13849-1 SILCL 3 according to IEC 62061 SIL 3 according to IEC 61508	2	–	1	ESR5-NO-21-24VAC-DC 118700	1 off 
			3	–	1	ESR5-NO-31-24VAC-DC 118702	1 off 
	dual-channel 24 V AC/DC, 230 V AC/DC, 50/60 Hz	Cat. 4 according to EN 954-1 PL e according to EN ISO 13849-1 SILCL 3 according to IEC 62061 SIL 3 according to IEC 61508	3	–	1	ESR5-NO-31-24V-230VAC-DC 118704	1 off 
	230 V AC, 50/60 Hz	Cat. 4 according to EN 954-1 PL e according to EN ISO 13849-1 SILCL 3 according to IEC 62061 SIL 3 according to IEC 61508	3	–	1	ESR5-NO-31-230VAC 119380	1 off 

Safety relays for emergency stop, guard door and light curtain monitoring



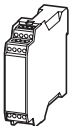

	Off-delayed ¹⁾ 24 V DC	Cat. 4 according to EN 954-1 PL e according to EN ISO 13849-1 SILCL 3 according to IEC 62061 SIL 3 according to IEC 61508 SIL 3 only for high demand requirements	2	2	0	ESR5-NV3-30 118705	1 off 
---	--------------------------------------	---	---	---	---	------------------------------	--

Two-hand relay, suitable for applications to EN 574 Typ III C

	dual channel 24 V DC, 24 V AC, 50/60 Hz	Cat. 4 according to EN 954-1 PL e according to EN ISO 13849-1 SILCL 3 according to IEC 62061 SIL 3 according to IEC 61508	2	–	1	ESR5-NZ-21-24VAC-DC 118703	1 off 
---	---	--	---	---	---	--------------------------------------	--

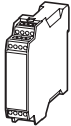
Contact expansion modules

The basic device determines the maximum stop category according to IEC 61508 and IEC 60204

	Off-delayed 24 V DC, 24 V AC, 50/60 Hz	Cat. 3 according to EN 954-1 PL d according to EN ISO 13849-1 SILCL 2 according to IEC 62061 SIL 2 according to IEC 61508	–	4	2	ESR5-VE3-42 118706	1 off 
	Non-delayed 24 V DC, 24 V AC, 50/60 Hz	Cat. 4 according to EN 954-1 PL e according to EN ISO 13849-1 SILCL 3 according to IEC 62061 SIL 3 according to IEC 61508	5	–	2	ESR5-NE-51-24VAC-DC 118707	1 off 

Notes

¹⁾ Suitable for safety position switch with guard locking LS-S...MT-ZBZ.

Information relevant for export to North America

	
Product Standards	IEC/EN see Technical Data; UL 508; CSA-C22.2 No. 14-95; CE marking
UL File No.	E29184
UL CCN	NKCR, NKCR7
CSA File No.	UL report applies to both US and Canada
CSA Class No.	3211-83; 3211-03
NA Certification	UL Listed, certified by UL for use in Canada
Degree of Protection	IEC: IP20, UL/CSA Type: -

Electronic safety relays

Basic devices, contact expansion modules

Technical data

ESR5

		unit	ESR5-NO-21...	ESR5-NO-41...	ESR5-NO-31-24VAC-DC
General					
Standards			EN ISO 13849-1, IEC 62061, IEC 61508, DIN EN 50178, UL/CUL listed		
Type-dependent standards			-	-	-
Lifespan, mechanical	c (contacts)	$\times 10^6$	10	10	10
Maximum operating frequency					
Max. operating frequency		Ops/h	3600	3600	3600
Climatic proofing			Cold according to EN 60068-2-1, dry heat according to EN60068-2-2, damp heat according to EN 60068-2-3	Dry heat according to EN60068-2-2, damp heat according to EN 60068-2-3	Cold according to EN 60068-2-1, dry heat according to EN60068-2-2, damp heat according to EN 60068-2-3
Ambient temperature		°C	-20 - 55	-20 - 55	-20 - 55
Ambient temperature storage		°C	-25 - 75	-25 - 75	-25 - 75
Mounting position			Any	Any	Any
Vibration resistance (IEC/EN 60068-2-6)			2 g, frequency: 10 – 150 Hz, amplitude: 0.15 mm	2 g, frequency: 10 – 150 Hz, amplitude: 0.15 mm	2 g, frequency: 10 – 150 Hz, amplitude: 0.15 mm
Shock resistance (IEC 60068-2-27)			-	-	-
Protection type					
Housing			IP20	IP20	IP20
Terminals			IP20	IP20	IP20
Protection against direct contact when actuated from front (IEC 0106 Part 100)			Finger- and back-of-hand proof	Finger- and back-of-hand proof	Finger- and back-of-hand proof
Weight		kg	0.17	0.22	0.17
Terminal capacity					
Solid or flexible		mm ²	1 x (0.2 - 2.5) 2 x (0.2 - 1)	1 x (0.2 - 2.5) 2 x (0.2 - 1)	1 x (0.2 - 2.5) 2 x (0.2 - 1)
Flexible with ferrule		mm ²	1 x (0.25 - 2.5) 2 x (0.25 - 1)	1 x (0.25 - 2.5) 2 x (0.25 - 1)	1 x (0.25 - 2.5) 2 x (0.25 - 1)
Solid or stranded		AWG	24 - 12	24 - 12	24 - 12
Terminal screw					
Pozidriv screwdriver		Size	2	2	2
Flat-blade screwdriver		mm	0.6 x 3.5	0.6 x 3.5	0.6 x 3.5
Max. tightening torque		Nm	0.6	0.6	0.6
Main contacts					
Rated impulse withstand voltage	U_{imp}	V AC	6000	4000	4000
Overvoltage category/pollution degree					
Outside			III/2	III/2	III/2
Inside			-	-	-
Rated insulation voltage	U_i	V AC	250	250	250
Rated operating voltage	U_e	V AC	230	230	230
Rated operation current					
AC-15					
230 V (360 ops./h)	I_e	A	5	4	5
230 V (3600 ops./h)	I_e	A	3	3	3
DC-13					
24 V (360 ops./h)	I_e	A	6	4	6
24 V (3600 ops./h)	I_e	A	3	2.5	3
Max. summation current of all poles					
24 V AC/DC devices		A	72	72	72
230 V AC devices		A	-	-	-
Square of the total current (and total current) of all current paths			72 A ² (6 + 6)	72 A ² (4.2 + 4.2 + 4.2 + 4.2)	72 A ² (4.9 + 4.9 + 4.9)
Short-circuit protection					
Max. fuse		A gG/gL	10	6	10

ESR5-NZ-21...	ESR5-NO-31-230VAC	ESR5-NO-31-24V-230VAC-DC	ESR5-NV3...	ESR5-VE3...	ESR5-NE-51...
EN ISO 13849-1, IEC 62061, IEC 61508, DIN EN 50178, UL/CUL listed					
EN 574 Part no. IIIC	EN 60204 (if applicable)	EN 60204 (if applicable)	EN 60204 (if applicable)	-	-
10	10	10	10	10	10
3600	3600	3600	3600	900	3600
Dry heat according to EN60068-2-2, damp heat according to EN 60068-2-3	Dry heat according to EN60068-2-2, damp heat according to EN 60068-2-3	Dry heat according to EN60068-2-2, damp heat according to EN 60068-2-3	Cold in accordance with: EN 60068-2-1, dry heat in accordance with EN 60068-2-2, humidity storage test in accordance with 60068-2-78	Dry heat according to EN60068-2-2, damp heat according to EN 60068-2-3	Dry heat according to EN60068-2-2, damp heat according to EN 60068-2-3
-20 - 55	-20 - 55	-20 - 55	-20 - 45	-20 - 55	-20 - 55
-25 - 75	-25 - 75	-25 - 75	-25 - 75	-25 - 75	-25 - 75
Any	Any	Any	Any	Any	Any
2 g, frequency: 10 – 150 Hz, amplitude: 0.15 mm	2 g, frequency: 10 – 150 Hz, amplitude: 0.15 mm	2 g, frequency: 10 – 150 Hz, amplitude: 0.15 mm	2 g, frequency: 10 – 150 Hz, amplitude: 0.15 mm	2 g, frequency: 10 – 150 Hz, amplitude: 0.15 mm	2 g, frequency: 10 – 150 Hz, amplitude: 0.15 mm
-	-	-	-	-	-
IP20	IP40	IP40	IP20	IP20	IP20
IP20	IP20	IP20	IP20	IP20	IP20
Finger- and back-of-hand proof	Finger- and back-of-hand proof	Finger- and back-of-hand proof	Finger- and back-of-hand proof	Finger- and back-of-hand proof	Finger- and back-of-hand proof
0.22	0.3	0.3	0.17	0.17	0.22
1 x (0.2 - 2.5) 2 x (0.2 - 1)	1 x (0.2 - 2.5) 2 x (0.2 - 1)	1 x (0.2 - 2.5) 2 x (0.2 - 1)	1 x (0.2 - 2.5) 2 x (0.2 - 1)	1 x (0.2 - 2.5) 2 x (0.2 - 1)	1 x (0.2 - 2.5) 2 x (0.2 - 1)
1 x (0.25 - 2.5) 2 x (0.25 - 1)	1 x (0.25 - 2.5) 2 x (0.25 - 1)	1 x (0.25 - 2.5) 2 x (0.25 - 1)	1 x (0.25 - 2.5) 2 x (0.25 - 1)	1 x (0.25 - 2.5) 2 x (0.25 - 1)	1 x (0.25 - 2.5) 2 x (0.25 - 1)
24 - 12	24 - 12	24 - 12	24 - 12	24 - 12	24 - 12
2	2	2	2	2	2
0.6 x 3.5	0.6 x 3.5	0.6 x 3.5	0.6 x 3.5	0.6 x 3.5	0.6 x 3.5
0.6	0.6	0.6	0.6	0.6	0.6
6000	6000	6000	4000	4000	4000
III/2	III/2	III/2	II/2	III/2	III/2
-	-	-	-	-	-
250	250	250	250	250	250
230	230	230	230	230	230
4	4	4	-	5	4
3	3	3	3	3	3
4	4	4	-	6	4
2.5	2.5	2.5	3	3	2.5
72	50	50	49	50	50
-	50	50	-	-	-
72 A ² (6 + 6)	50 A ² (4 + 4 + 4)	50 A ² (4 + 4 + 4)	50 A ² (4 + 4 + 4)	49 A ² (3.5+3.5+3.5+3.5)	50 A ² (3.7 + 3.7 + 3.7 + 3.7 + 3.7)
6	6	6	10	10	6

Electronic safety relays

Basic devices, contact expansion modules

ESR5

	unit	ESR5-NO-21...	ESR5-NO-41...	ESR5-NO-31-24VAC-DC
Power supply circuit				
Actuating voltage 50/60 Hz	V AC	24	24	24
Actuating voltage	U_s V DC	24	24	24
Voltage tolerance pick-up voltage	\times_e	0.85 - 1.1	0.85 - 1.1	0.85 - 1.1
Power consumption				
AC operated 50/60 Hz	VA	-	-	-
AC operated 50/60 Hz	W	3.4	3.4	3.4
DC operated	W	1.6	1.6	1.6
Fuse for control circuit supply				
24 V		Short-circuit proof	Short-circuit proof	Short-circuit proof
115 V/230 V		-	-	-
Control circuit				
Rated output voltage	V DC	24	24	24
Rated operational current	mA	S12, S22: 30, S34: 45	S12: 65, S34: 40	S12, S22: 30, S34: 45
Resistance	R	50	22	50
Short-circuit current	A	2.3	2.3	2.3
Response time	ms	100	65	100
Recovery time	ms	-	-	-
Response time with reset monitoring	t_{A1} ms	-	-	-
Response time without reset monitoring	t_{A2} ms	100	65	100
Reset time	t_R/t_{R1} ms	Single-channel 45; dual-channel 10	45	Single-channel 45; dual-channel 10
Minimum On Duration	t_M ms	-	-	-
Recovery time	t_W ms	Approx.1000	Approx.1000	Approx.1000
Synchronous monitoring time	t_S ms	-	-	-
Electromagnetic compatibility (EMC)				
Emitted interference		EN 61000-6-4	EN 61000-6-4	EN 61000-6-4
Interference immunity		According to EN 61000-6-2, EN 62061	According to EN 61000-6-2	According to EN 61000-6-2, EN 62061
Safety technical data				
	www.moeller.net/de/products_solutions/safety/safety_values			

ESR5-NZ-21...	ESR5-NO-31-230VAC	ESR5-NO-31-24V-230VAC-DC	ESR5-NV3...	ESR5-VE3...	ESR5-NE-51...
24	230	24 - 230	-	-	24
24	-	230	24	24	24
0.85 - 1.1	0.85 - 1.1	0.85 - 1.1	0.85 - 1.1	0.85 - 1.1	0.8 - 1.1
-	-	-	-	-	-
3	5.8	5.8	-	-	2.2
1.5	2.9	2.9	1.8	2	2.2
Short-circuit proof	-	Short-circuit proof	-	-	-
-	Short-circuit proof	Short-circuit proof	-	-	-
24	24	24	24	24	24
S11, S21: 60, Y2: 45	S10, S12, S22: 35, S34, S35: 45	S10, S12, S22: 35, S34, S35: 45	S12, S22: 3.5, S34, S35: 7	A1, A2: 84, K1/K2: 5	A1, A2: 92
22	11	11	500	-	-
2.3	0.7	0.7	0.1	-	-
50	250	250	150	20	20
-	-	-	-	-	-
-	60	60	150	20	20
50	250	250	150	20	20
20	20	20	20 (non-delayed enable paths); 100 (min. delayed enable paths)	0.3 - 3 s (+ 50 %) adjustable	20
-	-	-	-	-	-
Approx.1000	Approx.1000	Approx.1000	Approx.330	Approx.1000	-
500	-	-	-	-	-
EN 61000-6-4	EN 61000-6-4	EN 61000-6-4	EN 61000-6-4	EN 61000-6-4	EN 61000-6-4
According to EN 61000-6-2	According to EN 61000-6-2	According to EN 61000-6-2	According to EN 61000-6-2, EN 62061	According to EN 61000-6-2	According to EN 61000-6-2

Dimensions

Safety relays, contact expansion modules

ESR5...24VAC-DC

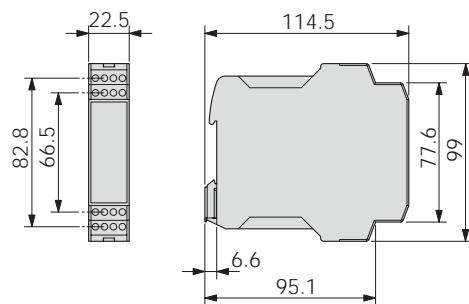

ESR5...230VAC...

