

UPS (1-10kVA) Series  
**User Manual**



# Foreword

## Summaries

Thank you for choosing UPS!

This document gives a description of the (1-10kVA) UPS(hereinafter referred to as UPS), including the features, performance, appearance, structure, working principles, installation, operation, maintenance, transportation and storage, etc.

Please save the manual after reading, in order to consult in the future.









### NOTE

The figures in this manual are just for reference, for details please see the actual product.

## Symbol Conventions

The manual quotes the safety symbols, these symbols used to prompt users to comply with safety matters during installation, operation and maintenance. Safety symbol meaning as follows.

Symbol	Description
 <b>DANGER</b>	Alerts you to a high risk hazard that could, if not avoided, result in serious injury or death.
 <b>WARNING</b>	Alerts you to a medium or low risk hazard that could, if not avoided, result in moderate or minor injury.
 <b>CAUTION</b>	Alerts you to a potentially hazardous situation that could, if not avoided, result in equipment damage, data loss, performance deterioration, or unanticipated results.
	Anti-static prompting.
	Be care electric shock prompting.
 <b>TIP</b>	Provides a tip that may help you solve a problem or save time.

Symbol	Description
 NOTE	Provides additional information to emphasize or supplement important points in the main text.

Product standard: Q/ZZKJ 001

## Change History

Changes between document issues are cumulative. The latest document issue contains all the changes made in earlier issues.

### Issue 001 (2017-09-01)

First issue.

# Contents

<b>1 Safety Description.....</b>	<b>1</b>
1.1 Safety Announcements.....	1
1.1.1 Use Announcements.....	1
1.1.2 Battery Announcements .....	2
1.1.3 ESD Protection.....	3
1.2 Working Environment Requirements .....	3
<b>2 Overview.....</b>	<b>4</b>
2.1 Product Intro.....	4
2.1.1 Model Meaning .....	4
2.1.2 Features .....	4
2.2 Appearance .....	5
2.2.1 Operation Panel.....	7
2.2.2 Rear Panel View.....	10
2.2.3 Intelligent Slot.....	14
2.2.4 EPO Connector .....	15
2.2.5 RS232 Communication .....	15
2.3 Working Principles .....	16
2.3.1 Working Mode .....	16
2.3.2 UPS Parameters Setting .....	19
<b>3 Installation.....</b>	<b>21</b>
3.1 Unpacking and Checking .....	21
3.1.1 1kVA(L)/ 2kVA (L)/ 3kVA (L)/ 6kVA(L)/ 10kVA(B).....	21
3.1.2 6kVA/10kVA(S) .....	21
3.2 Installation Preparation .....	23
3.2.1 Input Breaker Selection.....	23
3.2.2 Selection of the Cross-sectional Area of Wire.....	24
3.3 Electrical Connection .....	24

---

3.3.1 1kVA(L) .....	25
3.3.2 2kVA(L)/3kVA(L).....	26
3.3.3 6kVA/6kVA(L).....	27
3.3.4 10kVA/10kVA(S)/10kVA(B) .....	29
3.3.5 Intelligent Slot Installation.....	32
<b>4 Operation and Maintenance .....</b>	<b>33</b>
4.1 Check Before Startup .....	33
4.2 Startup Operation .....	33
4.2.1 1kVA(L)/ 2kVA (L)/3kVA (L).....	33
4.2.2 6kVA(L)/ 10kVA(B) /10kVA(S) .....	34
4.3 Shutdown Operation.....	34
4.3.1 1kVA(L)/2kVA (L)/3kVA (L).....	34
4.3.2 6kVA (L)/10kVA (B) /10kVA(S).....	34
4.4 Parallel System Operation.....	35
4.4.1 Start Parallel System .....	35
4.4.2 Close Parallel System.....	35
4.4.3 Remove Faulty UPS from Parallel System .....	36
4.4.4 Add New UPS into Parallel System .....	36
4.4.5 Redundancy Function of Parallel System .....	36
4.5 Periodic Preventative Maintenance .....	36
4.6 Battery Maintenance .....	37
4.7 Maintenance Bypass Mode(Only for UPS with Maintenance Bypass).....	37
4.8 Troubleshooting.....	38
<b>5 Package, Transportation, Storage.....</b>	<b>42</b>
5.1 Package .....	42
5.2 Transportation .....	42
5.3 Storage .....	42
<b>Appendix A Technical Specifications.....</b>	<b>43</b>
<b>Appendix B Acronyms and Abbreviations .....</b>	<b>47</b>

---

# 1 Safety Description

This chapter mainly describes the safety announcements. Prior to performing any work on the device, please read the user manual carefully, follow the operation and installation instructions and observe all danger, warning and safety information, which is to avoid human injury and device damage by irregular operations.

## 1.1 Safety Announcements

This section mainly describes the safety announcements when operation and maintenance. For details, please refer to safety description in the relevant chapters.



### CAUTION

Before using UPS, please read the announcements and operation instructions in this section carefully to avoid accident.

The promptings in the user manual, such as "Danger", "Warning", "Caution", etc. don't include all safety announcements. They are just only the supplement of safety announcements when using UPS.

---



### NOTE

Any device damage caused by violating the general safety operation requirements or safety standards of design, production, and usage will be out of warranty range.

### 1.1.1 Use Announcements



### DANGER

There exists high temperature and high voltage inside UPS. When using UPS, please strictly comply with all warnings and operation instruments on the UPS and in the user manual.

---

**CAUTION**

Only authorized professionals are allowed to open the UPS chassis to avoid electric shock. Otherwise, if it causes UPS failure, it is out of the guarantee range.

---

**CAUTION**

UPS is a class A product. When it is applied to residential building, additional measures should be taken to prevent harassment.

---

- Ensure that no liquid or other foreign objects can enter into UPS.
- UPS must be grounded well.
- If UPS has to be moved, rewired or maintained, it must disconnect all electrical connection, such as AC power, battery power, etc. to isolate power. It can't perform any work on the UPS until UPS is powered off completely( $\geq 10$ min). Otherwise, the output may have electricity, which may cause electric shock.
- When dismantling fan, do not put fingers or tools into the rotating fan until it has stopped working to avoid device damage or human injury.
- Do not connect unbalance load, half-wave rectification load or inductive load in the output of UPS, such as air-condition, blower, starter, electric drill, motor, daylight lamp, etc.
- In case of fire, use dry powder extinguisher to put out the fire. If you use liquid fire extinguisher, it may cause electric shock.

### 1.1.2 Battery Announcements

---

**CAUTION**

Please use specified model battery ! Non-specified model battery will lead to UPS damage.

---

- Only authorized professional can replace battery. When operation, take off conductive objects, such as watch, bracelet, bangle, ring, etc., wear rubber shoes and gloves and use tools with insulated handle.
-



- Don't put tools or other conductive objects on the battery.
- It's prohibited to connect the anode of battery with the cathode of battery or connect them reversely, which is to avoid fire or electric shock.
- Before connecting or disconnecting the battery terminals, disconnect charger first.
- The battery must be with the same type, model, and manufacturer.
- Battery should be kept away from fire source or all electrical equipments that may easily cause spark avoid human injury.
- Don't open or destroy battery. The electrolyte in the battery includes some dangerous objects, such as strong acid, which will be harmful to skin and eyes. If it is careless to touch the electrolyte, clean it by a lot of water immediately and then check it in the hospital.
- The waste battery should be disposed according to the local regulations.

### 1.1.3 ESD Protection



#### **CAUTION**

To prevent human electrostatic damaging sensitive components(such as circuit board), make sure that to wear a anti-static wrist strap before touching sensitive components, and the other end of wrist strap is well grounded.

---

## 1.2 Working Environment Requirements

- Don't install UPS where it would be exposed to direct sunlight, in rain or in moist environments.
- Don't install UPS where it is with conductive metal dust or nearby heater.
- Generally, the working temperature is  $-5^{\circ}\text{C} \sim +40^{\circ}\text{C}$  and the relative humidity is 0%RH $\sim$ 95%RH that is with no condensation(The recommended working temperature is  $20^{\circ}\text{C} \sim 25^{\circ}\text{C}$  and the recommended relative humidity is about 50%).
- Put UPS in the flat floor without vibration and the vertical gradient is less than  $5^{\circ}$  . Keep good ventilation around UPS. The clearance between the rear or the side of UPS and adjacent devices or wall should be at least 300mm $\sim$ 500mm. Poor ventilation will rise temperature inside UPS, which will reduce the working life of inner components and then affect the working life of UPS.
- The recommended altitude is lower than 1000m. If exceeding 1000m, it need to decrease the rated power according to GB3859.2-93.

## 2 Overview

This chapter mainly describes the model meaning, features, structure and working principle, etc.

### 2.1 Product Intro

(1-10kVA) UPS are with all high frequency, pure online, double-conversion, intelligent features. They are the perfect power security for file server, enterprise server, center server, mirco-computer, concentrator, telecom system, data center and others that require high quality power protection. They are widely applied to the many key business areas, such as post, finance, network, stock, railway, etc.

(1-10kVA) UPS are with the single-phase AC input and single-phase AC output. Each series UPS includes standard and long backup models.

#### 2.1.1 Model Meaning

UPS that the output power is less than 6kVA

"L" means long backup model. If there is no "L" symbol, it means standard model.

UPS that the output power is not less than 10kVA

"/B" means that the product can be used in the parallel system; "S" means standard model. If there is no "S" symbol, it means long backup model.

#### 2.1.2 Features

**Intelligent RS232 communication**

Through the RS232 standard data port and UPS power management software, it can realize the three remote function between the computer and UPS, monitor the running and electrical data of UPS on the computer, perform ON/OFF operation remotely and support SNMP network adaptor (external, connect with UPS through RS232 port), which makes UPS be a network new member.

**High input power factor**

Adopt the advanced active PFC technology, which eases load in the power grid. It is the new generation green power.

## High cost performance

Adopt many kinds of power conversions and high frequency PWM technologies, which is with high efficiency, small volume, light weight, improves the running reliability and reduces cost.

## Perfect protection

Equipped with the functions, such as output over-voltage protection, battery under-voltage protection, input over-voltage protection, triple over-current protection, etc. and solve the problems of the high frequency UPS, such as poor adaptability in the power grid and weak anti-impact ability.

## Low mains input voltage

Adopt the independent rapid detection technology. When the mains input voltage is 120V, which is the lower limit, the battery still doesn't discharge. Therefore, in the mains mode, all output power gets from the power grid, which is to ensure the battery is still in the 100% energy storage status, reduce the battery discharge times and prolong the working life.

## 2.2 Appearance

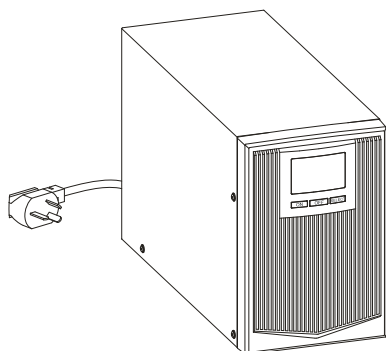

Figure2-1 Appearance of 1kVA(L)

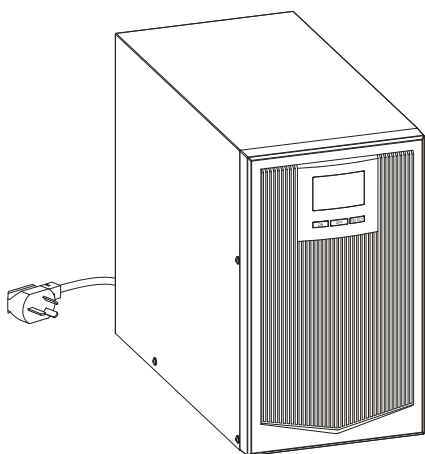

Figure2-2 Appearance of 2kVA(L)/ 3kVA (L)/ 6kVA (L)/10kVA

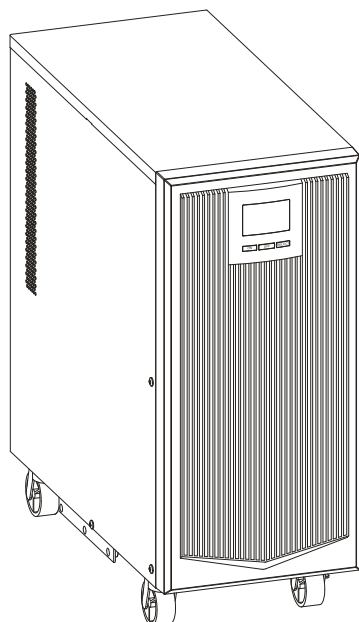

Figure2-3 Appearance of 6kVA/10kVA (S)

### 2.2.1 Operation Panel

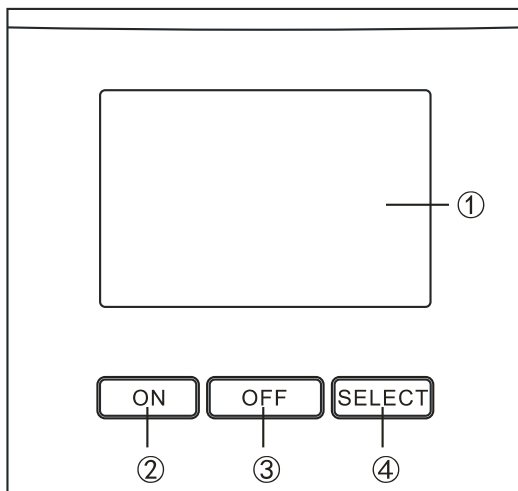

Figure2-4 Operation panel

Table2-1 The illustration of operation panel

No.	Name	Illustration
○,1	LCD	Display the working status and setting of UPS.
○,2	"ON" button	<ul style="list-style-type: none"> <li>● When UPS is off, press and hold "ON" button for 1s to turn on UPS.</li> <li>● When UPS is on and works in the mains mode, press and hold "ON" button for 3s to do the battery test. When UPS works in the battery mode, press and hold "ON" button for 3s to silence the buzzer(cancel the mains abnormal alarm).</li> <li>● In the set page, press and hold "ON" button for 1s to confirm the setting.</li> </ul>
○,3	"OFF" button	When UPS is on, press and hold "OFF" button for 1s to turn off UPS.
○,4	"SELECT" button	<ul style="list-style-type: none"> <li>● Press "SELECT" button to transfer the display information, such as output voltage, output frequency, input voltage, input frequency, battery voltage, inner temperature, load percentage, fault information, etc.</li> <li>● Press and hold "SELECT" button for 5s to enter the set page. Then press "SELECT" button to transfer the setting information, such as PAR/SGL mode(only available for parallel system), ECO/INV mode or the inverting output voltage that is 208V/220V/230V/240V, and</li> </ul>

No.	Name	Illustration
		press "ON" button to confirm the setting.

LCD panel

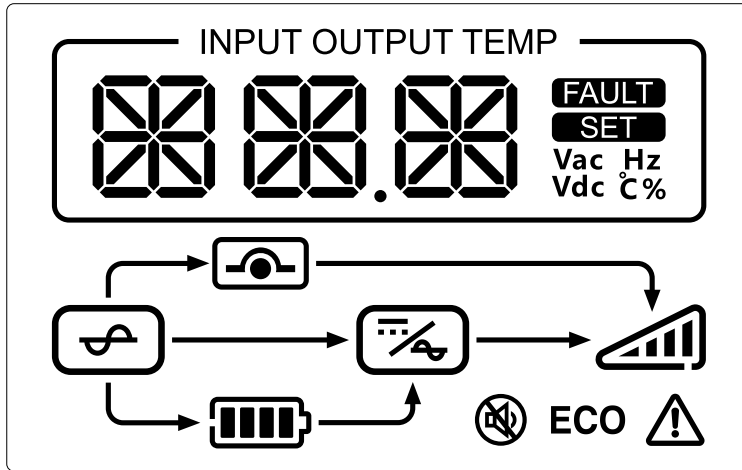





Figure2-5 LCD panel

Table2-2 The illustration of LCD panel

No.	Icon	Illustration
1		It shows input voltage, input frequency, output voltage, output frequency, load percent, temperature, fault code, parameters or working mode, etc.
2		Mains icon ON: Mains input is normal.
3		Bypass icon ON: UPS works in the bypass mode.
4		Battery icon: four energy bars 1. When the energy bars light on from left to right again and again, it indicates battery is in charge. 2. When all energy bars are on, it indicates battery is fully charged. 3. When all energy bars flicker, it indicates battery is over-voltage.

No.	Icon	Illustration
		4. When all energy bars are off and the frame flickers, it indicates battery is about to run out.
5		Inverting icon ON: Inverter is working.
6		Load icon: four energy bars 1. The energy bars from left to right indicates the load level. 2. When all energy bars flicker, it indicates load is too large.
7		Silence icon ON: Buzzer is in the silence status.
8	<b>ECO</b>	ECO mode icon ON: UPS works in the ECO mode.
9		Alarm icon ON: UPS failure.

## 2.2.2 Rear Panel View

1kVA(L)

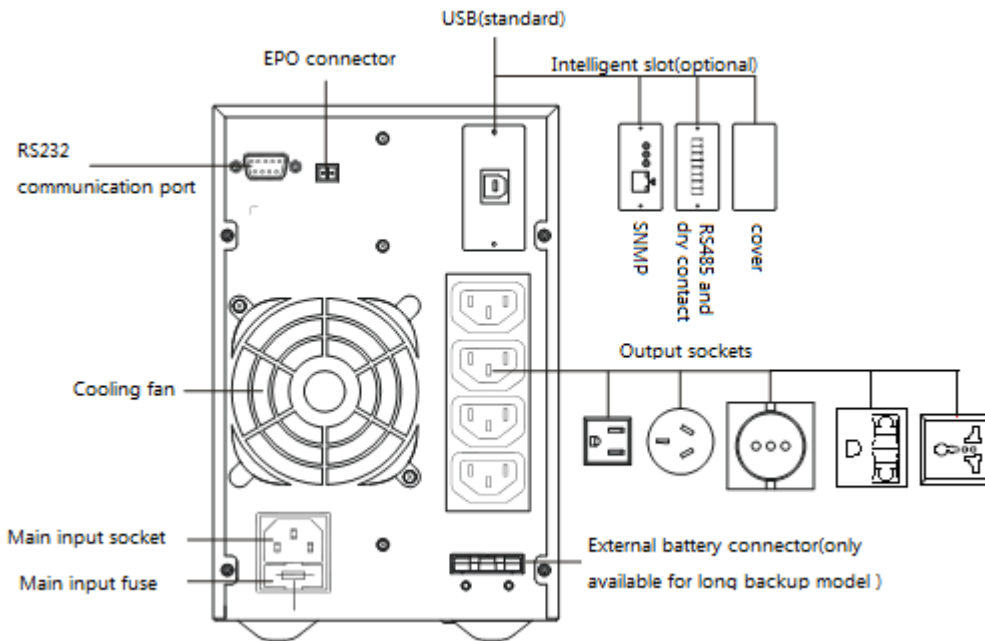

Figure2-6 Rear panel of 1kVA(L)



2kVA(L)/3kVA(L)

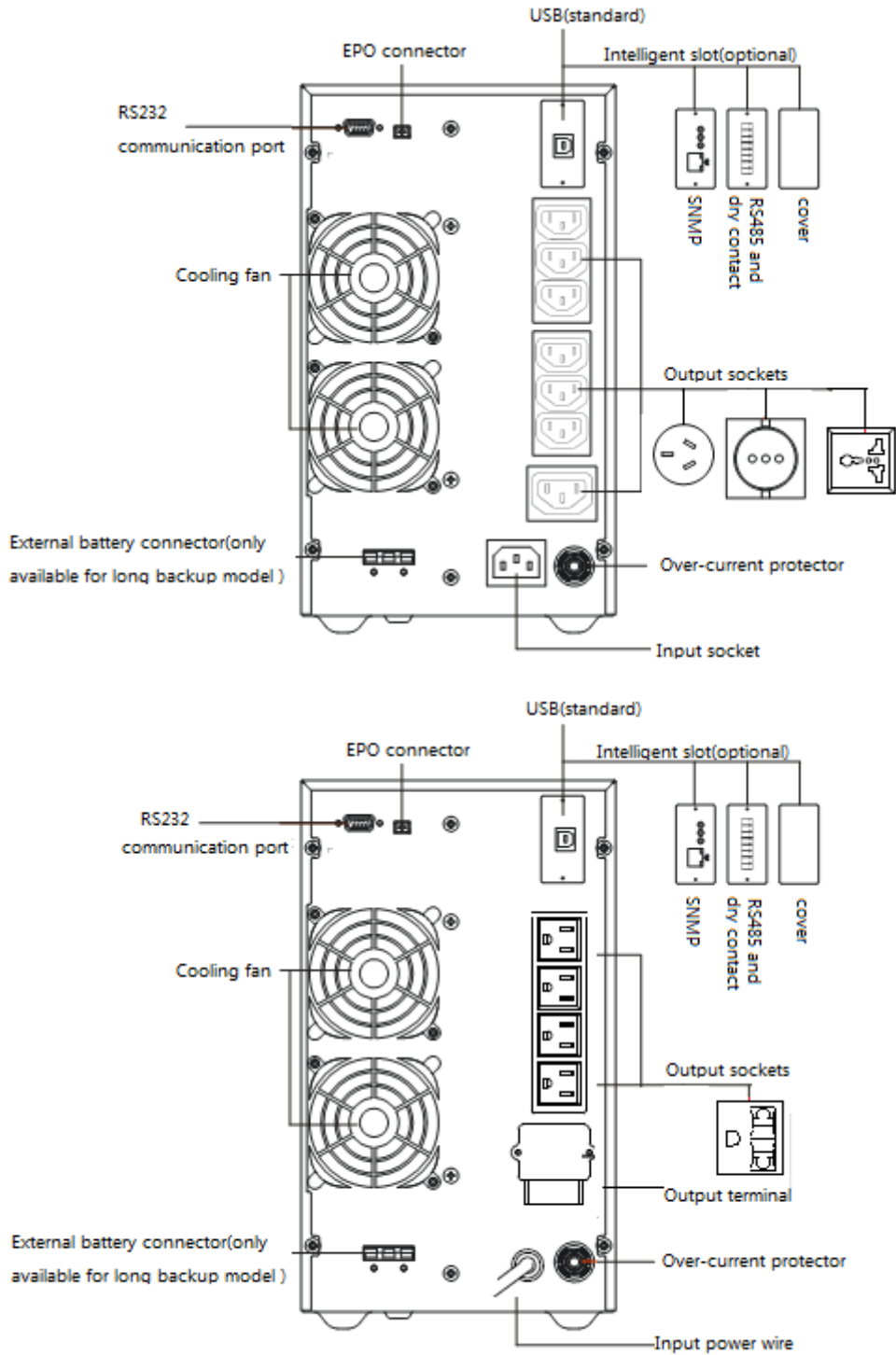

Figure2-7 Rear panel of 2kVA(L)/3kVA(L)

6kVA/6kVA(L)

- 6kVA standard model

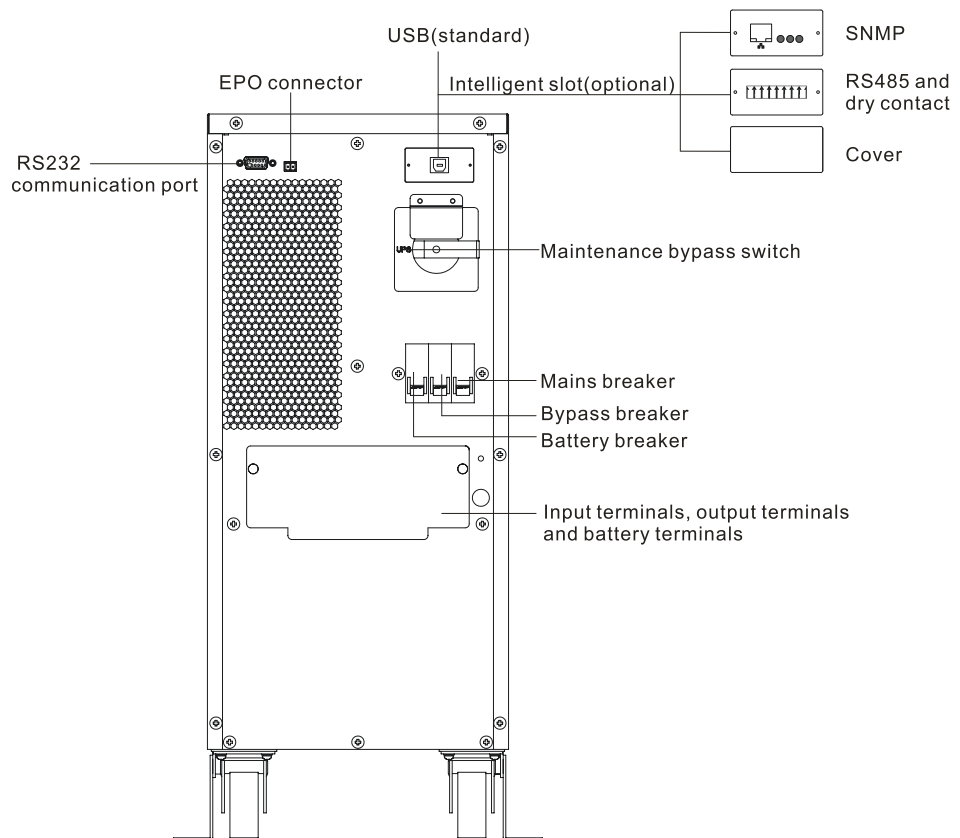

Figure2-8 Rear panel of 6kVA

- 6kVA(L) long backup model

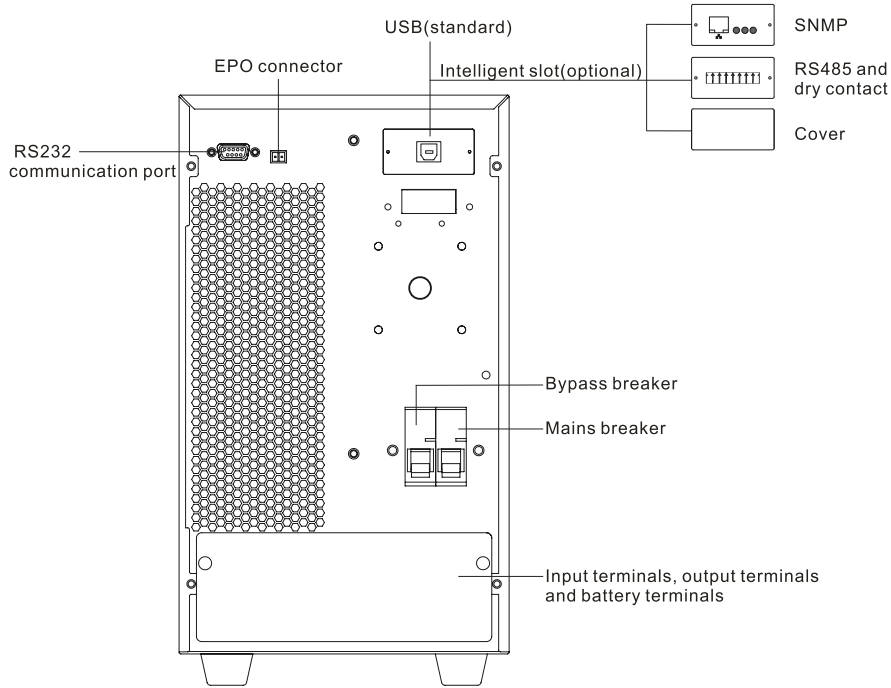

Figure2-9 Rear panel of 6kVA(L)

10kVA(B) /10kVA(S)

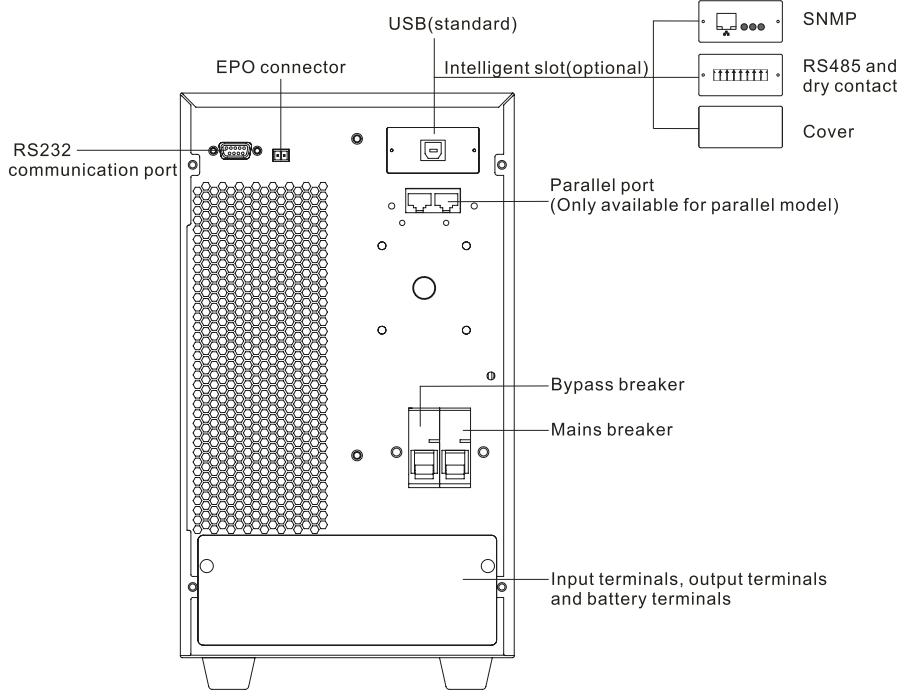

Figure2-10 Rear panel of 10kVA(B)

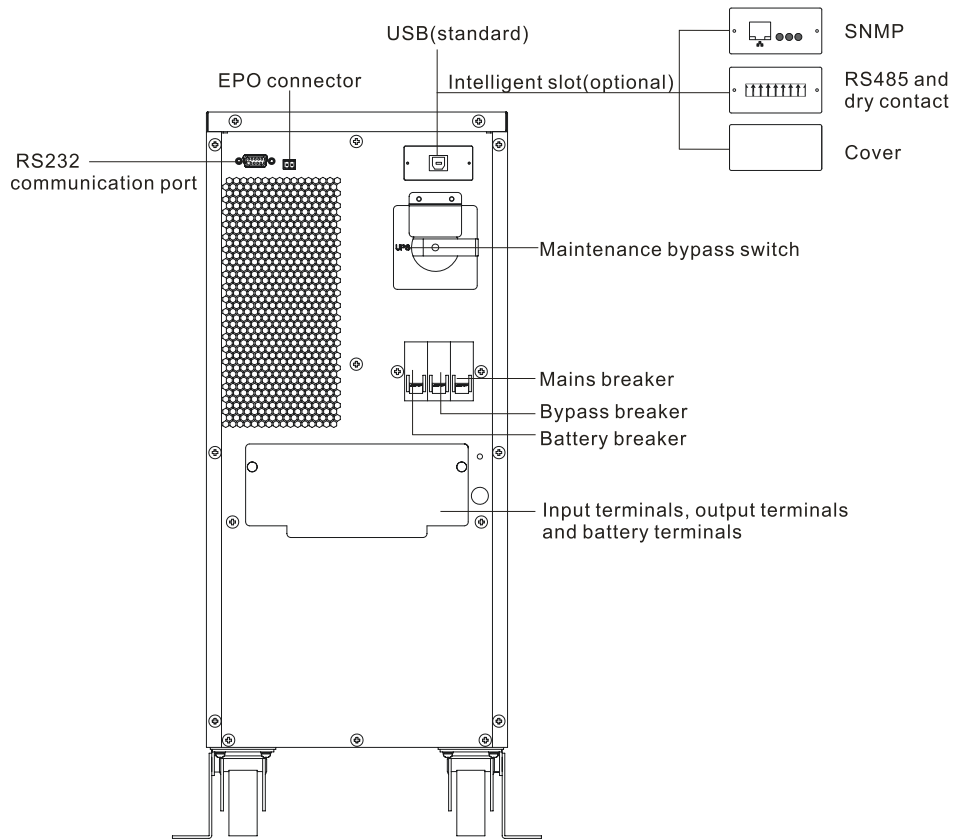

Figure2-11 Rear panel of 10kVA(S)

### 2.2.3 Intelligent Slot

#### RS485 and dry contact(optional)

The pin sequence and pin definition of RS485 and dry contact is as shown in Figure2-12 and Figure2-13.

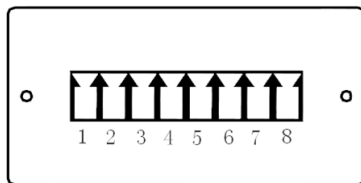

Figure2-12 RS485 and dry contact

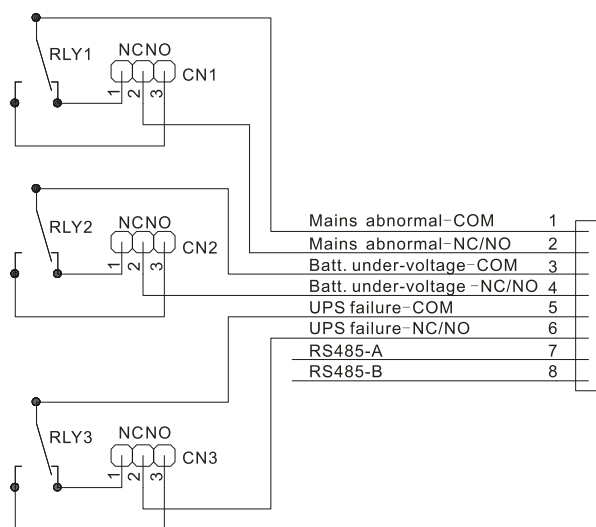

Figure2-13 Pin definition of RS485 and dry contact

The illustration of dry contact is as below:

1. CN1, CN2, CN3 determine that dry contact output signal is normal open or normal close. In default, dry contact output signal is normal close, that is PIN1 connects with PIN2. If one route signal needs to set to normal open, connect PIN2 with PIN3.
2. The requirements for input signal of dry contact: the voltage should be less than 60Vdc or 42Vac RMS and the current should be less than 1.25A.

### 2.2.4 EPO Connector

When connecting two ports in the EPO connector together, UPS will close output. If it needs to recover output, disconnect two ports in the EPO connector and power UPS off, and then restart UPS.

### 2.2.5 RS232 Communication

The corresponding pin relationship between RS232 port of UPS and RS232 port of PC is as shown in Table2-3.

Table2-3 The corresponding pin relationship between RS232 port of UPS and RS232 port of PC

RS232 port of UPS	RS232 port of PC
9 (3)	2 (receiving end)
6 (2)	3 (transmitting end)
7 (5)	5 (grounding end)

## 2.3 Working Principles

When the mains is normal, the input of UPS (1-10kVA) series converts into the  $\pm 360\text{V}$  steady DC voltage through PFC, which supplies power for DC/AC inverter to output steady 220V AC and charges battery at the same time. When the mains is abnormal, the battery will boost into the  $\pm 360\text{V}$  DC voltage for DC/AC inverter through DC/DC.

The working principles of UPS (1-10kVA) series is as shown in Figure2-14. The DC/AC inverter adopts half bridge structure and the DC/DC boost adopts the push-pull circuit or boost circuit. PFC is the correction circuit for active power factor.

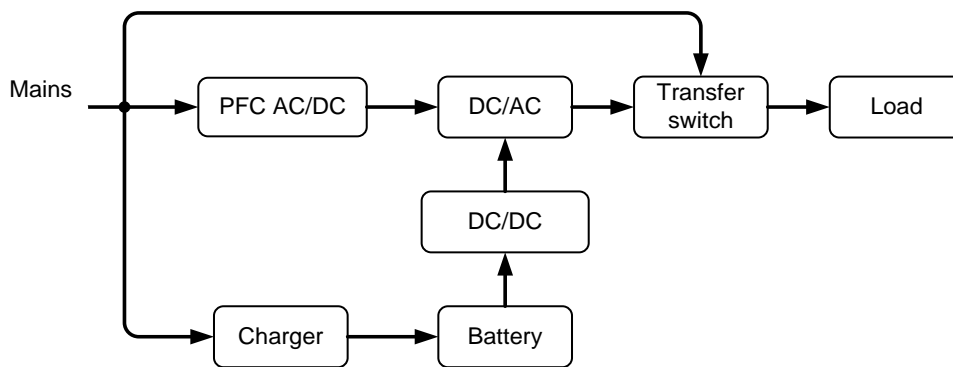

Figure2-14 The working principle of UPS (1-10kVA) series

### 2.3.1 Working Mode

#### Mains mode

When the mains works, UPS will work in the mains mode and charge battery. The LCD display is as shown in Figure2-15.

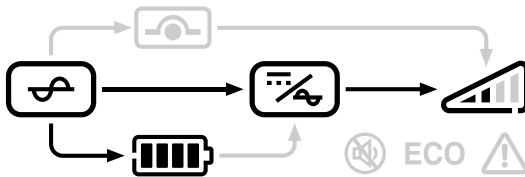

Figure2-15 Mains mode

#### Bypass mode

UPS works in the bypass mode and charges battery. The LCD display is as shown in Figure2-16.

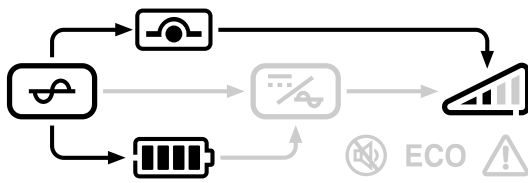

Figure2-16 Bypass mode

### Battery mode

When the mains is abnormal, it will work in the battery mode. The LCD display is as shown Figure2-17.

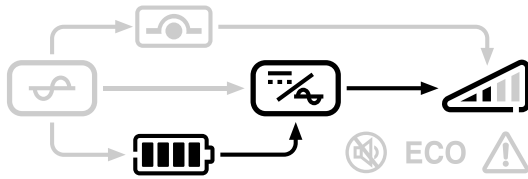

Figure2-17 Battery mode

### Fault status

UPS faults include: EPO protection, busbar voltage fault, IGBT over-temperature fault, fan fault(including fan blocked, fan damage, etc.), output fault(including output overload protection, output short-circuit, etc.), battery fault(including battery over-voltage protection, battery under-voltage protection, etc.), parallel wire disconnected fault, parameter error, charger fault(including charger over-temperature, charger short-circuit, etc.), bypass fault, inner power fault, etc. The corresponding fault status displayed in the LCD is as shown in Figure2-18 to Figure2-27.

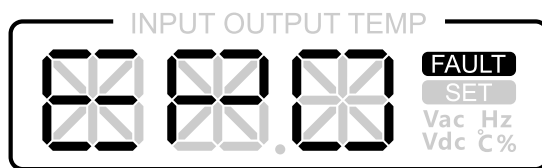

Figure2-18 EPO protection

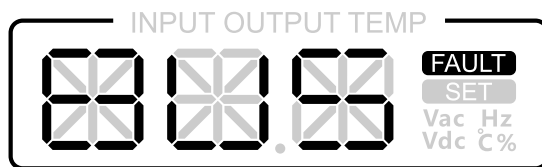

Figure2-19 Busbar voltage fault

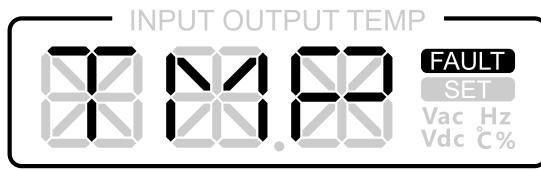

Figure2-20 IGBT over-temperature fault

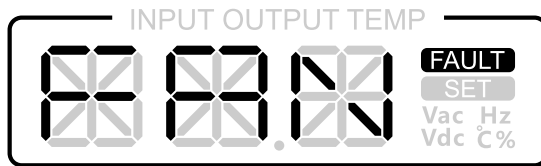

Figure2-21 Fan fault

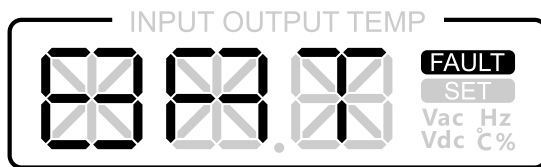

Figure2-22 Battery fault

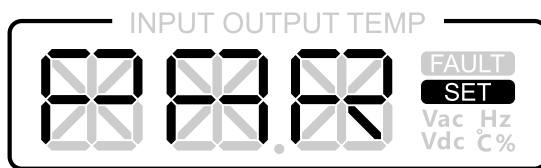

Figure2-23 Parameters error

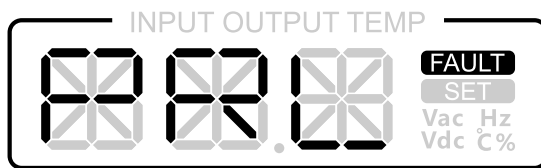

Figure2-24 Parallel wire disconnected fault

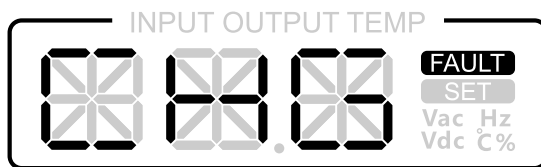

Figure2-25 Charger fault



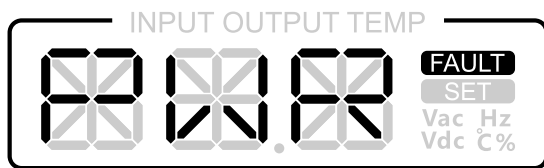

Figure2-26 Inner power fault

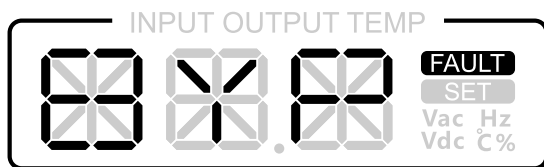

Figure2-27 Bypass fault

### 2.3.2 UPS Parameters Setting

Press and hold "SELECT" button for 5s to enter the set page. Then press "SELECT" button to transfer the setting information, such as PAR/SGL mode(only available for parallel system), ECO/INV mode or the inverting output voltage that is 208V/220V/230V/240V, and press "ON" button to confirm the setting.

#### PAR mode(only available for parallel system)

"PAR" set page: When system works in the SGL mode and it has to set to PAR mode, in the set page, three characters "PAR" flicker. If you confirm the selection, press and hold "ON" button more than 1s to quit the set page, the setting is successful. If you aren't sure the selection, it will quit the set page 20s later automatically. In the PAR mode, the LCD display is as shown Figure2-28.

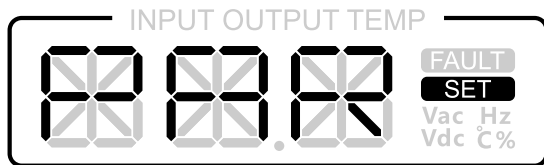

Figure2-28 PAR mode

#### SGL mode(only available for parallel system)

"SGL" set page: When system works in the PAR mode and it has to set to SGL mode, in the set page, three characters "SGL" flicker. If you confirm the selection, press and hold "ON" button more than 1s to quit the set page, the setting is successful. If you aren't sure the selection, it will quit the set page 20s later automatically. In the SGL mode, the LCD display is as shown Figure2-29.

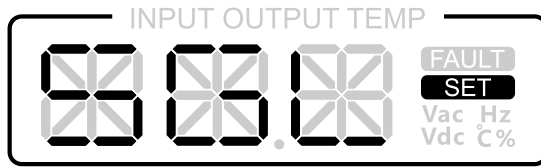

Figure2-29 SGL mode

**NOTE**

PAR mode and SGL mode are only available for parallel system. It only can show PAR mode or SGL mode alternatively in the LCD. When it is in the PAR mode, it shows three characters "SGL" in the set page. It can set the working mode to the SGL mode. When it is in the SGL mode, it shows three characters "PAR" in the set page. It can set the working mode to the PAR mode.

### ECO mode

"ECO" set page: In the set page, three characters "ECO" flicker. If you confirm the selection, press and hold "ON" button more than 1s to quit the set page, the setting is successful. If you aren't sure the selection, it will quit the set page 20s later automatically. In the ECO mode, the LCD display is as shown Figure2-30.

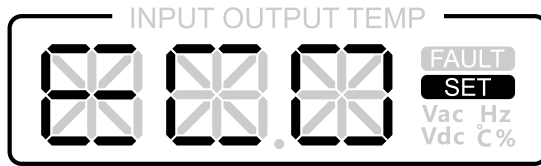

Figure2-30 ECO mode

### INV mode

"INV" set page: In the set page, three characters "INV" flicker. If you confirm the selection, press and hold "ON" button more than 1s to quit the set page, the setting is successful. If you aren't sure the selection, it will quit the set page 20s later automatically. In the INV mode, the LCD display is as shown Figure2-31.

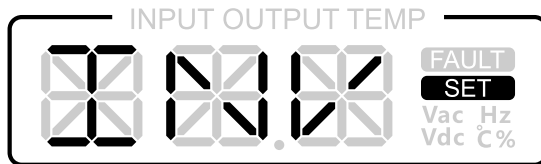

Figure2-31 INV mode

The setting of the inverting output voltage that is 208V/220V/230V/240V is the same to the above method.

## 3 Installation

This chapter mainly describes installation, including the unpacking and checking, installation preparation, electrical connection, etc.

### 3.1 Unpacking and Checking

#### 3.1.1 1kVA(L)/ 2kVA (L)/ 3kVA (L)/ 6kVA(L)/ 10kVA(/B)

Besides 6kVA/10kVA(S) standard model, the package of the UPS (1-10kVA) series is carton.

Unpacking UPS and conduct the following items:

- Inspect the appearance for shipping damage. If any shipping damage is found, report it to the carrier immediately.
- Check the delivery list to see if the types of accessories are complete and correct. If there is any discrepancy, contact the distributor immediately.

#### 3.1.2 6kVA/10kVA(S)

The package of 6kVA/10kVA(S) standard model adopts the wooden bracket and carton. The unpacking procedures are as follow.

- Step 1 Check the appearance of package for shipping damage. If any shipping damage is found, report it to the carrier immediately.
- Step 2 Transport device to the installation site.



#### **CAUTION**

When using a forklift to move UPS, the end of arm of forklift should be beyond the wooden bracket to avoid falling.

---

- Step 3 Cut belts and remove them.
- Step 4 Remove the package and take out the optional components and user manual. The appearance after unpacking is as shown in Figure3-1.

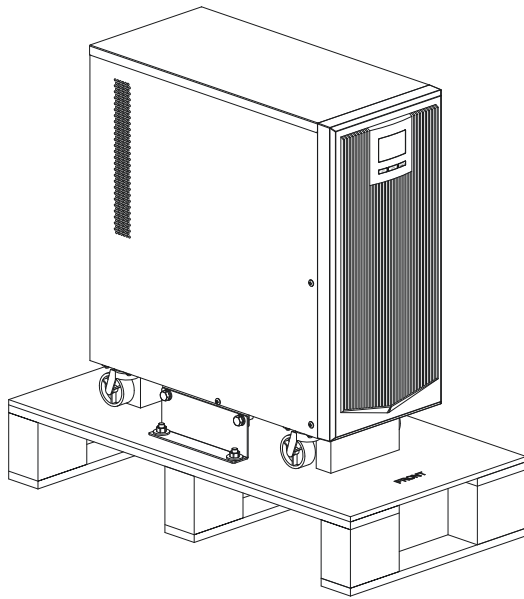

Figure3-1 Appearance after unpacking

Step 5 Check the device completeness.

- Inspect the appearance of device for shipping damage, if any shipping damage is found, report it to the carrier immediately.
- Check if the types of the accessories are complete and correct. If there is any discrepancy, take notes and contact the distributor immediately.

Step 6 If UPS is OK, dismantle four hexagonal bolts M8×20(two pieces on the left and right side respectively) between the anchor frame and anchor support plate, as shown in Figure3-2.

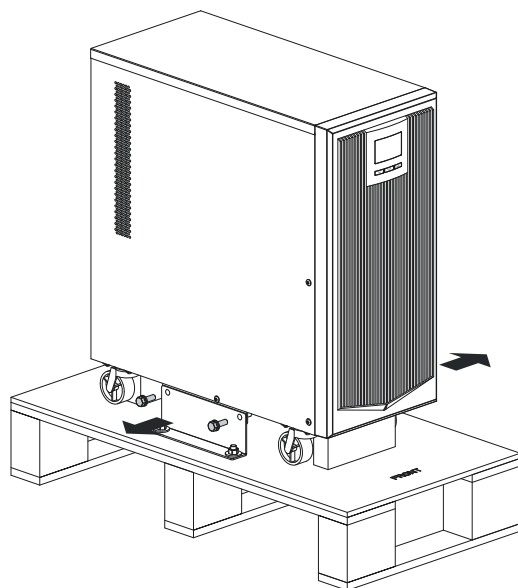

Figure3-2 Dismantle the hexagonal bolts

Step 7 Move UPS to floor and fasten it.

 **NOTE**

- After putting UPS in the floor, you can move it by four Omni-directional wheels at the bottom of UPS. When moving UPS, the Omni-directional wheels should be at ON position. After moving UPS, the Omni-directional wheels should be at OFF position to avoid UPS moving.
- For stability concern, after moving UPS to the installation place. It's recommend to dismantle the anchor frame in the wooden bracket and install it in the anchor support plate by four bolts M8\*20. If there has installation holes in the floor or other bases, fasten UPS in the floor or other bases through anchor.

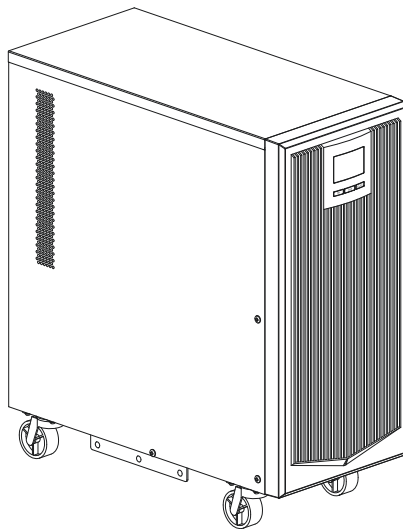

Figure3-3 Install UPS in the installation position

----End

## 3.2 Installation Preparation

### 3.2.1 Input Breaker Selection

Add a breaker(It's recommended that the breaker is with backfeed protection and bipolar disconnection function) or a power distribution box in the input wire of UPS, which matches with the power of UPS, to isolate the mains. Consider the charging power of UPS and the transient current impact when power on, the current of the selected breaker should be 1.5~2 times of the max. input current of UPS. Besides, the selected breaker should be without the power leakage protection to avoid mis-operation. The distribution box is better to be made by the professional company. The selection of input breaker refers to Table3-1.

Table3-1 The recommended input breaker of (1-10kVA) UPS

Model \ Index	AC input (A)		DC input (long backup model) (A)	
	Max. current	Breaker	Max. current	Breaker
1kVA(L)	6	10	37	50
2kVA(L)	12	20	37	50
3kVA (L)	18	32	42	50
6kVA (L)	36	50	39	50
10kVA/10KVA(S)	60	100	65	100

### 3.2.2 Selection of the Cross-sectional Area of Wire

For the selection of the cross-sectional area of AC input wire, AC output wire and battery wire of 6kVA (L), 10kVA, 10kVA(S), please refer to Table3-2 for the corresponding recommended value and choose upwards.

Table3-2 The ampacity of the recommended cross-sectional area of wire

		KR1000(L)	KR2000(L)	KR3000(L)	KR6000(L)	KR(/B)1110 /KR1110S
AC input (Neutral/live)	Rated current(A)	5.4	10.8	15.6	30.2	48.5
	Cross-sectional area of wire (mm <sup>2</sup> )	1.5	2.5	4	6	10
AC output (Neutral/live)	Rated current(A)	4.5	9.1	13.6	27.3	45.5
	Cross-sectional area of wire (mm <sup>2</sup> )	1.5	2.5	4	6	10
DC input(Long backup model)	Rated current(A)	29.0	27.8	31.3	30.6	52.0
	Cross-sectional area of wire (mm <sup>2</sup> )	6	6	6	6	10

		KR1000(L)	KR2000(L)	KR3000(L)	KR6000(L)	KR(/B)1110 /KR1110S
Ground	Cross-sectional area of wire (mm <sup>2</sup> )	1.5	2.5	4	6	10

### 3.3 Electrical Connection

Before performing the electrical connection, ensure all breakers in the rear panel of UPS, external mains upstream switch, external battery upstream switch are all disconnected. It's prohibited to perform wiring when power on.



#### **CAUTION**

Place wires in such a way that no one can step on or trip over them.

---

#### 3.3.1 1kVA(L)

In the 1kVA(L) series UPS, the input and output adopt sockets. When using it, please connect one end of the input power wire with input socket and then connect the other end of the input power wire with mains socket. Besides, connect the load power wire with the output socket. The wiring for the input and output of the 1kVA(L) series UPS is as shown in Figure3-4.

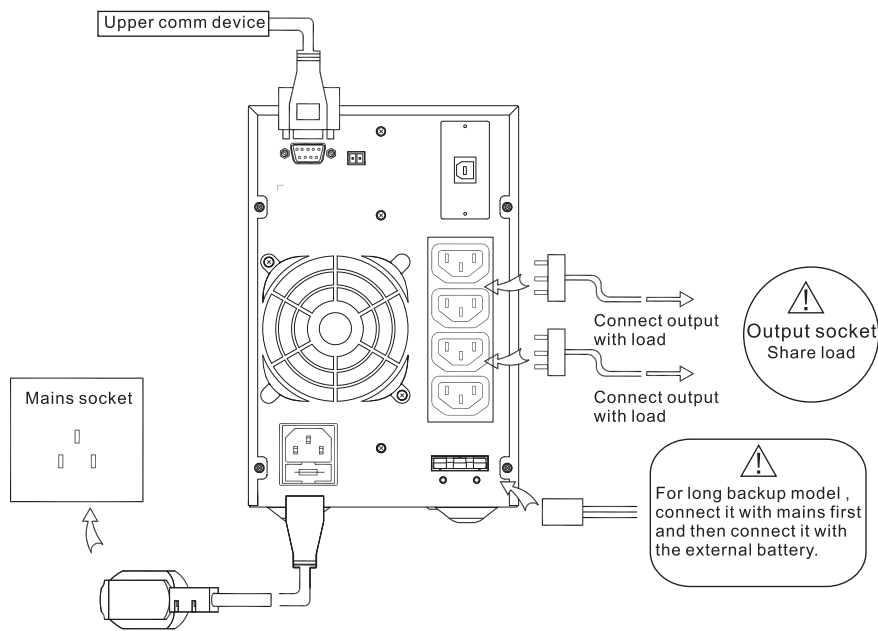

Figure 3-4 Wiring diagram of 1kVA(L)

 **NOTE**

For long backup model, connect it with battery wire. Connect the three-core plug of battery wire of battery cabinet with the three-core socket in the rear panel of UPS. The installation and wiring for battery cabinet refers to the battery cabinet user manual.



**CAUTION**

Mains socket should be installed near UPS and convenient to operate.

For long backup model, connect it with mains first and then connect it with the external battery.

Generally, the load current of each output socket should be not more than 5A.

### 3.3.2 2kVA(L)/3kVA(L)

In the 2kVA (L)/3kVA (L) series, the input and output adopt sockets. When using it, please connect one end of the input power wire with input socket and then connect the other end of the input power wire with mains socket. Besides, connect the load power wire with the output socket. The wiring for the input and output of 2kVA(L)/3kVA(L) series UPS is as shown in Figure 3-5.



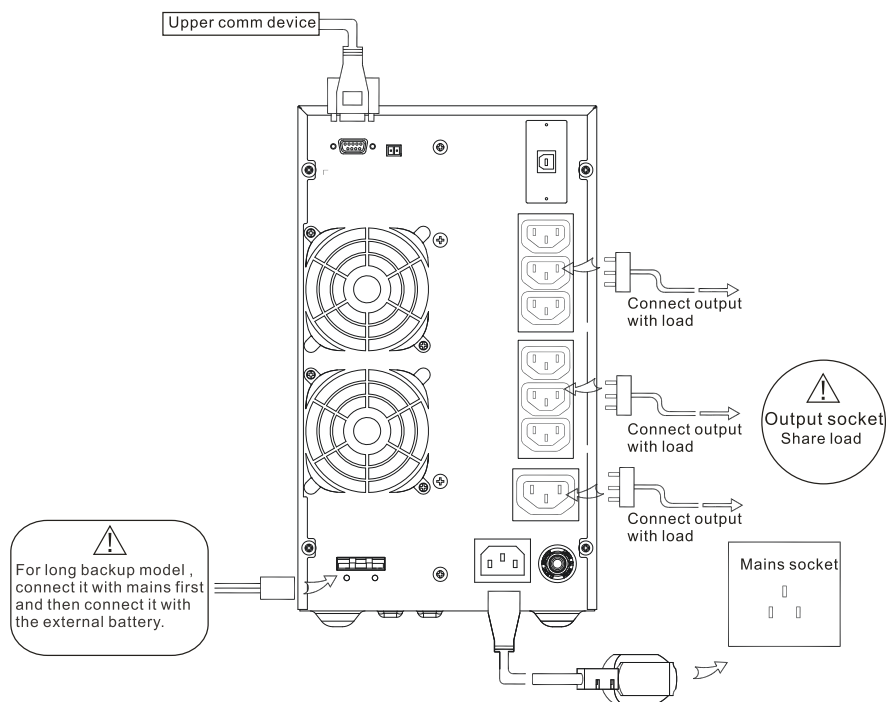

Figure3-5 Wiring diagram of 2kVA(L)/3kVA(L)

**NOTE**

For long backup model, connect it with battery wire. Connect the three-core plug of battery wire of battery cabinet with the three-core socket in the rear panel of UPS. The installation and wiring for battery cabinet refers to the battery cabinet user manual.



**CAUTION**

Mains socket should be installed near UPS and convenient to operate.

For long backup model, connect it with mains first and then connect it with the external battery.

Generally, the load current of each output socket should be not more than 5A.

### 3.3.3 6kVA/6kVA(L)

In the 6kVA(L) series UPS, the input, output and battery adopt the terminal bar. The wiring for the 6kVA series UPS is as shown in Figure3-6 and the wiring for the 6kVA(L) series UPS is as shown in Figure3-7.

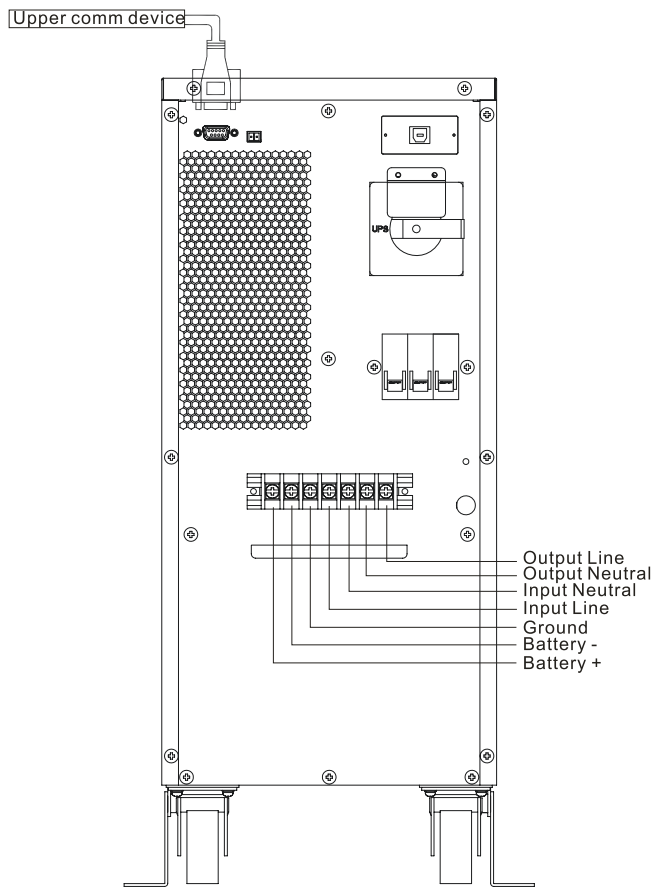

Figure3-6 Wiring diagram of 6kVA

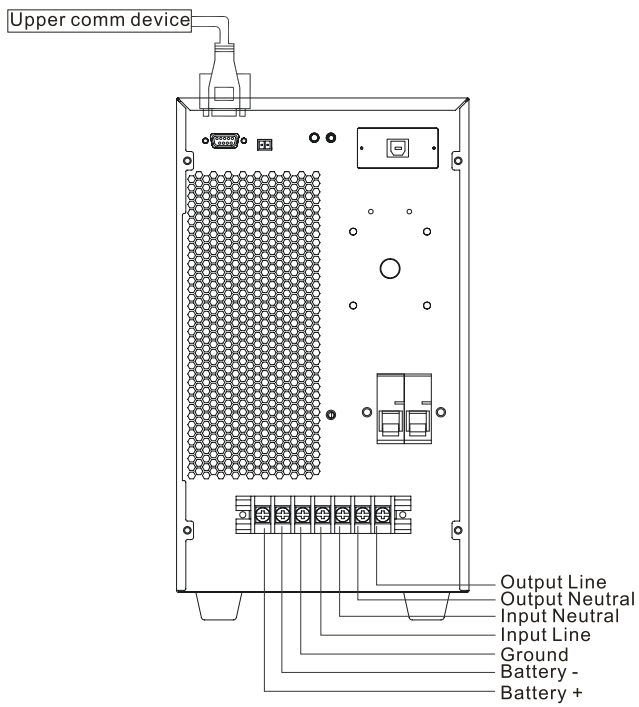

Figure3-7 Wiring diagram of 6kVA(L)

### 3.3.4 10kVA/10kVA(S)/10kVA(/B)

#### 10kVA

In the 10kVA series UPS, the input, output and battery adopt the terminal bar. The wiring for the 10kVA series UPS is as shown in Figure3-8.

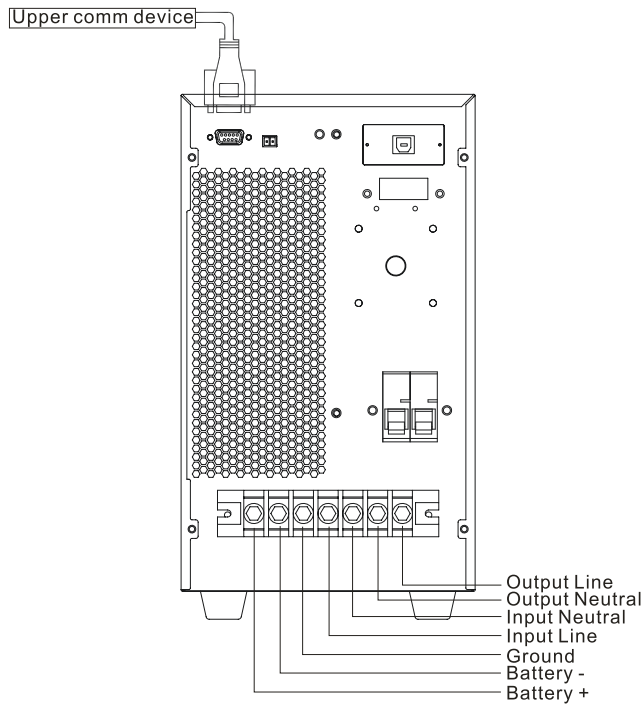

Figure3-8 Wiring diagram of 10kVA

#### 10kVA(S)

In the 10kVA(S) series UPS, the input, output and battery adopt the terminal bar. The wiring for the 10kVA(S) series UPS is as shown in Figure3-9.

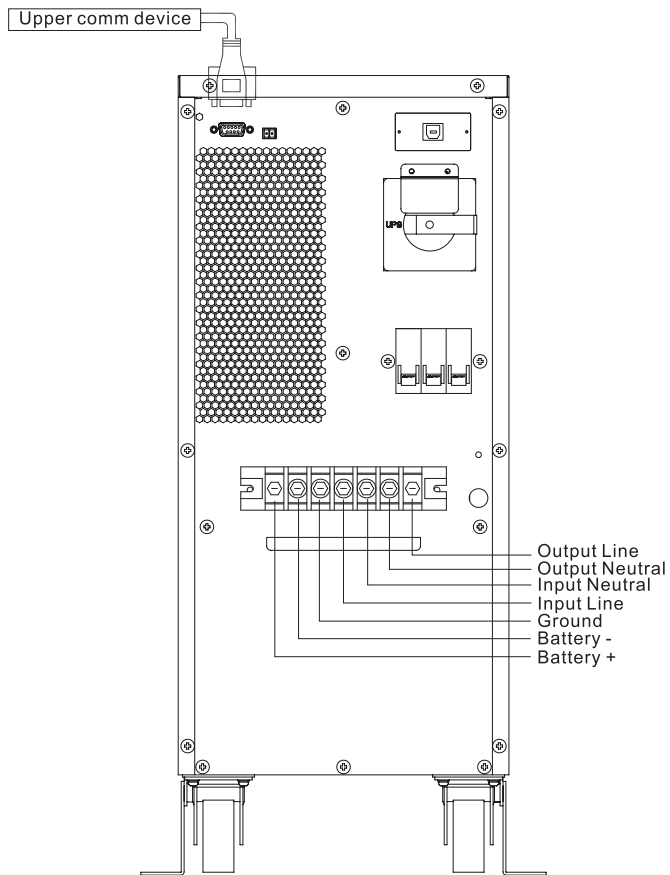

Figure3-9 Wiring diagram of 10kVA (S)

### 10kVA(/B)

- Step 1 Install the battery and UPS of each UPS respectively according to the above description.
- Step 2 Connect the AC output of each UPS with the output distribution box, as shown in Figure3-10.

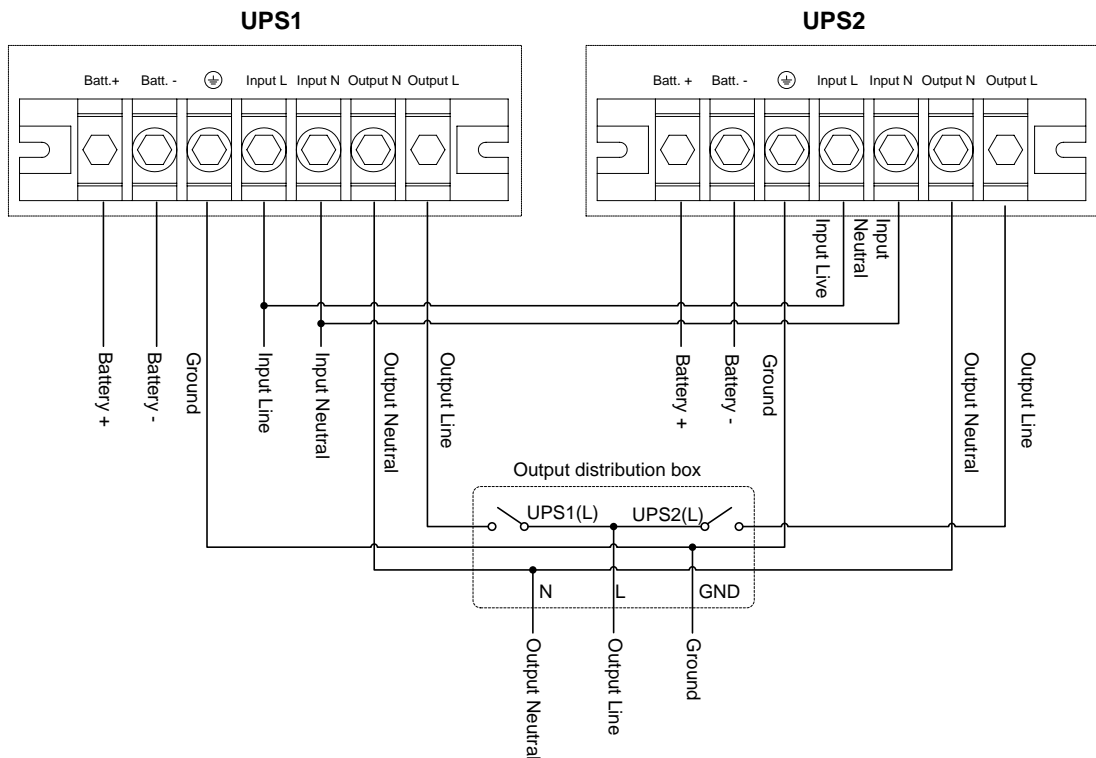

Figure3-10 Wiring diagram of 10kVA(B) parallel system

- Step 3 Connect the equipped parallel wires with parallel port in the rear panel of each UPS in the parallel system.



### CAUTION

1. The wiring method and phase sequence of the input of each UPS in the parallel system should be the same. Besides, the bypass power of parallel system should be the in-phase.
2. Each UPS in the parallel system is connected to an independent battery pack. It's prohibited that two UPS use the same battery pack.
3. Connect the equipped parallel wires with parallel port in the rear panel of each UPS in the parallel system. Two RJ45 parallel ports are the same, that will have redundancy to improve reliability. If there has a parallel port disconnected, UPS will have an alarm. After connecting the parallel wires, fasten them in the rear panel holes of each UPS by cable ties.

----End

### 3.3.5 Intelligent Slot Installation

Step 1 Dismantle standard intelligent slot.

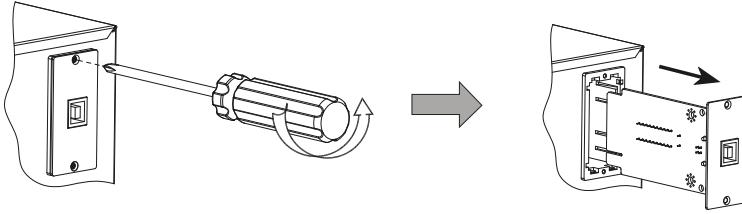

Figure3-11 Dismantle standard intelligent slot

Step 2 Install optional intelligent slot and fix it.

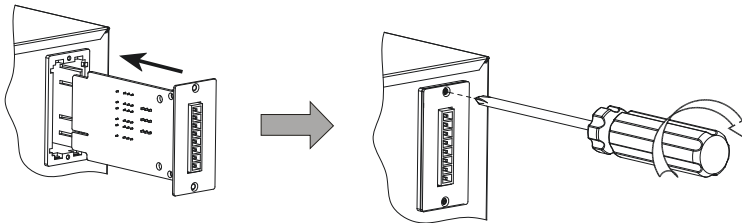

Figure3-12 Install optional intelligent slot

Step 3 Connect communication cable.

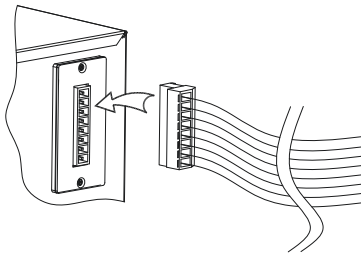

Figure3-13 Connect communication cable

----End

## 4 Operation and Maintenance

This chapter mainly describes the operation process, operation method, daily maintenance and troubleshooting, etc.

### 4.1 Check Before Startup

- Check if the wire connection is firm and the color of AC wires is in accordance with the specification.
- Check if UPS is grounded reliably.
- Check if the voltage between the neutral wire and grounding wire is less than 5Vac.
- If installing the remote monitoring device in the UPS, check if the wiring in the RS232 port is correct.
- If it is long backup model, check if the wiring between UPS and battery cabinet is correct and reliable.
- Check if the wiring is neat and the wire binding is in accordance with the specification.
- Check if the installation and wiring are good for transformation, expansion and maintenance in future.
- Check that there is no short-circuit in the output of UPS and the load capacity isn't beyond the rated capacity of UPS.

### 4.2 Startup Operation

#### 4.2.1 1kVA(L)/ 2kVA (L)/3kVA (L)

- Step 1 Connect UPS with mains socket.
- Step 2 Press "ON" button on the panel for 1s to start UPS.
- Step 3 About 10s later, if the UPS works steadily, start loads, such as PC, etc.



#### **CAUTION**

Start load with the sequence that "high power device→small power device", which is to avoid overload protection when starting high power device.

---

----End

#### 4.2.2 6kVA(L)/ 10kVA(/B) /10kVA(S)

- Step 1 Switch on the mains breaker, bypass breaker and battery breaker.
- Step 2 Press "ON" button on the panel for 1s to start UPS.
- Step 3 About 10s later, if the UPS works steadily, start loads, such as PC, etc.



#### CAUTION

Start load with the sequence that "high power device→small power device", which is to avoid overload protection when starting high power device.

---

----End

### 4.3 Shutdown Operation

#### 4.3.1 1kVA(L)/2kVA (L)/3kVA (L)

- Step 1 Close load and keep UPS running without load for about 10min to exhaust heat.
- Step 2 Press "OFF" button on the panel for 1s.
- Step 3 Unplug mains socket.

----End

#### 4.3.2 6kVA (L)/10kVA (/B) /10kVA(S)

- Step 1 Close load and keep UPS running without load for about 10min to exhaust heat.
- Step 2 Press "OFF" button on the panel for 1s.
- Step 3 Switch off the battery breaker, bypass breaker and mains breaker.

----End



## 4.4 Parallel System Operation

### 4.4.1 Start Parallel System



#### CAUTION

Don't start loads until parallel system have started completely. Ensure all breakers in the distribution box are switched off.

---

Start the parallel system following the procedures as below:

- Step 1 After installing parallel system correctly, start each UPS in the parallel system according to 4.2 Startup Operation successively.
- Step 2 When each UPS outputs, measure the inverting voltage of each UPS. The voltage difference between the max. voltage and the min. voltage should be less than 5V. Switch on breakers that connected with each UPS in the distribution box in 5min and check the circulation current of each UPS that should be less than 3A.
- If the voltage difference is more than 5V, check if the output of each UPS are all 220V. If the voltage difference is more than 10V, please contact your local distributor or service center for help. Besides, if the circulation current of each UPS is too large, it will damage inverter. If the circulation current of each UPS is more than 3A, please contact your local distributor or service center for help.
- Step 3 Switch on major output breaker and output breakers of each branch in the distribution box. Then start load successively.

**----End**

### 4.4.2 Close Parallel System

Generally, it is not recommended that turn on or turn off the parallel system frequently.

- Step 1 Close all loads;
- Step 2 Press "OFF" button in the panel of each UPS to shut down UPS successively.
- Step 3 Switch off breakers in the rear panel of each UPS.(In the daily operation, it's unnecessary to switch them off).

**----End**

### 4.4.3 Remove Faulty UPS from Parallel System

When one UPS failure, it will remove from parallel system automatically with sound&light alarm. Now, perform the operations shown in Figure4-1 to remove the faulty UPS from parallel system completely to achieve online hot maintenance or replacement.

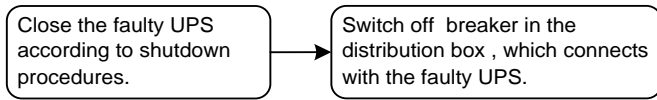

Figure4-1 Remove faulty UPS from parallel system



#### CAUTION

When the parallel system works normally, don't remove UPS from the parallel system until it's switched off, or the power system will work abnormally.

### 4.4.4 Add New UPS into Parallel System

When it has to add one or more UPS into parallel system, perform the operations shown in Figure4-2. When the added UPS works steadily, it will add into parallel system automatically for share current.

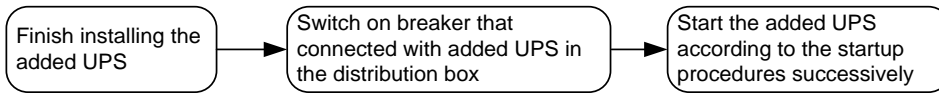

Figure4-2 Add new UPS into parallel system

### 4.4.5 Redundancy Funicton of Parallel System

When adopting the N+1 redundancy backup design, the total output load should be less than N times of rated load of single UPS. If there has a faulty UPS, it will remove form parallel system automatically, which doesn't influence system running and enhances system reliability. When the output load is more than N times of rated load of single UPS, the overload unit (more than N/(N+1) times of rated load of single UPS)will have an alarm. e.g. For the parallel system with two UPS, when the load of UPS is more than 50%, it will have overload alarm.

## 4.5 Periodic Preventative Maintenance

To improve the efficiency and reliability of UPS, perform the following maintenance regularly.

- Clean UPS regularly by dry cloth. Don't use liquid or spray cleaner. Before cleaning, shut down UPS.

- Check if the wiring in the input and output are firmly and connect well.
- Check the working status of cooling fans regularly. Prevent sundries from blocking the air outlet. If any damage, please replace it in time.
- Check the battery voltage and the working status of UPS regularly.

## 4.6 Battery Maintenance

The working life of battery is based on environment temperature and discharge times. Using battery in the high temperature for a long time or discharging battery deeply will reduce the working life of battery.

- Charge battery for ten hours before using it. During charging, it can use the battery. If the battery and charger are powered off at the same time, the discharging time will be less than the standard value.
- Generally, charge and discharge battery once every four to six months. Discharge battery till the battery is under-voltage and power it off and then charge it. In the high temperature area, charge and discharge battery once every two months. The charging time for the standard battery should be more than ten hours every time.
- If UPS hasn't been used for a long time, it is recommended to charge battery more than ten hours every three months.
- Generally, the working life of battery is three to five years. If battery failure, replace it early. The battery replacement should be performed by authorized professional.

## 4.7 Maintenance Bypass Mode(Only for UPS with Maintenance Bypass)

When it needs to maintain UPS or replace battery, but it can't stop supplying power for load, switch off UPS and transfer to bypass mode, dismantle the maintenance bypass cover and transfer the maintenance bypass switch from maintenance bypass to bypass and then switch off mains breaker and bypass breaker in the rear panel of UPS. Now, AC power draws through maintenance bypass switch to supply power for load.

**CAUTION**

In the maintenance bypass mode, there still exists electricity in the input terminals, output terminals, and the terminals in the filter board.

## 4.8 Troubleshooting

As shown in Table4-1, it only includes some common fault diagnosis. If any doubt, contact the local office or distributor for details.

Table4-1 Troubleshooting

Fault phenomenon	Possible reason
The mains is normal. When starting UPS, it outputs normally. But it works in the battery mode and the buzzer beeps intermittently.	<ol style="list-style-type: none"> <li>1) Check if the contacts and sockets in the input are with poor contact;</li> <li>2) Check if the input voltage amplitude or frequency of mains displayed in the LCD is beyond the allowable input range of UPS;</li> <li>3) Check if the over-current protector in the rear panel is sprung. If yes, press the over-current protector switch.</li> </ol>
After finishing installing UPS, connecting with power will fuse the fuse or cause power cut.	Output short circuit or wiring for three phase of output error.
When starting UPS, the LCD display and output are normal. But when connecting with load, it will stop outputting immediately.	<ol style="list-style-type: none"> <li>1) UPS is overload seriously or the output circuit is short-circuit. It should reduce load to the proper capacity or find the short-circuit reason. The common reason is that the output changeover socket is short-circuit or the input is short-circuit after UPS failure.</li> <li>2) It doesn't follow the startup sequence that "high power device → small power device" to start load. Restart UPS. When UPS works steadily, start high power device first, and start small power device successively.</li> </ol>
Buzzer long beeps, fault indicator is on, UPS works in the bypass mode	<ol style="list-style-type: none"> <li>1) The output is overload. The load is too heavy, which is beyond the rated power of UPS. It should reduce</li> </ol>

Fault phenomenon	Possible reason
and inverter failure.	<p>load or select UPS with larger power capacity. It is normal that UPS works in the bypass mode temporarily for load startup impact and then recover automatically</p> <p>2) UPS over-temperature protection. Check if the air inlet and air outlet of UPS is blocked or the working temperature of UPS is beyond the allowable range.</p>
Usually, UPS works normally. When UPS powers off, it doesn't transfer to battery mode or it transfers to battery mode and battery has under-voltage protection soon.	<p>1) Battery aging, battery capacity loss or it needs to replace battery.</p> <p>2) Battery charger fault. Usually, it can't charge battery.</p> <p>3) Battery wire doesn't connect well or the terminals are with poor contact.</p>
When the load is PC, everything works normally. When power failure, UPS works normally, but the computer halts.	The grounding is unreliable for the floating voltage between the neutral wire and the grounding wire is too high.

Table4-2 The meaning of fault symbol and buzzer status

Fault symbol	Buzzer status	Meaning	
Fault info. page (page up or page down by "SELECT" button)	EPO	Long beep	UPS has emergency protection(if equipped with EPO function), Bypass output and inverting output are all closed.
	BUS	Long beep	There has busbar voltage fault in the UPS, the inverting output is closed.
	TMP	Long beep	UPS has over-temperature protection, the inverting output is closed. Please check if cooling fan damage and air vents blocked.
	FAN	Rapid beep (Alarm once about every 0.2s)	Fan fault alarm prompting, the inverting output is going to protect. Please check if cooling fan damage.

Fault symbol		Buzzer status	Meaning
		Long beep	Fan fault protection. The inverting output is closed.
	OUT	Long beep	Output fault, please check if output is short-circuit or the load is too large.
	BAT	Long beep	Battery fault, battery voltage too low or too high protection.
	PRA	Long beep	Parameters error in the parallel system. Please check if the inverting voltage format or the parallel mode setting(PRA mode and SGL mode) is different.
	PRL	Long beep	Parallel wire in the parallel system disconnected.
	PWR	Long beep	Power failure. If it is abnormal, repair it in time.
	CHG	Rapid beep (Alarm once about every 0.2s)	<ol style="list-style-type: none"> <li>1. Charger over-temperature protection(Please check if the cooling fan in the charging board failure);</li> <li>2. Output short-circuit protection in the charger.</li> </ol>
	BYP	Slow beep (Alarm once about every 2.0s)	In the mains mode, bypass voltage or bypass frequency abnormal. Please check if the bypass breaker is switched on.
	CAN	Slow beep (Alarm once about every 2.0s)	CAN communication abnormal in the parallel system. Please check if paralleled wire is damaged or only a UPS in the parallel system powers on.
Load energy bars all flicker		Rapid beep (Alarm once about every 0.2s)	Output overload alarm. the output is going to close, please reduce load.
Battery energy bar all flicker		Slow beep (Alarm once about every 2.0s)	Battery voltage is too high. Please check if battery or charger failure.
Battery energy bars		Rapid beep (Alarm once about every 0.2s)	Battery is about to run out. Please pay attention

---

Fault symbol	Buzzer status	Meaning
are all off and the frame flickers	once about every 0.2s)	to protect device and save you data in the PC.

**NOTE**

The above information is for user to know some common fault diagnosis when UPS failure. If it may be inner components failure, please contact the professional.

# 5 Package, Transportation, Storage

## 5.1 Package

The package of product is carton. When packing, pay attention to the placing direction requirements. One side of carton, it should print warning icons, including keep dry, handle with care, up, stacking layer limit, etc. The other side of carton, it should print the device model, etc. Print device name on the front of carton.

## 5.2 Transportation

Pay attention to warnings on the carton. Don't impact it severely when transportation. In case of damaging device, it should follow the placing direction that shows on the carton. Don't carry device with the objects that inflammable, explosive, or corrosive. Don't put device in the open-air warehouse when transshipment. Leaching and mechanical damage by rain, snow or liquid objects is prohibited.

## 5.3 Storage

When storing device, it should follow the placing direction that shows on the carton. The gap is 20cm between the carton and ground and the clearance is at least 50cm from carton to wall, heat source, cold source, windows or air inlet.

The storage environment temperature is 0°C~40°C and the relative humidity is 20%~80%. In warehouse, It's prohibited that there has poisonous gas, objects that inflammable and explosive, corrosive chemical objects. Besides, it shouldn't have too strong mechanical shaking, impact and strong magnetic field. Under the storage conditions above, the storage period is six months. If it is beyond six months, it has to recheck. When long term storage ,it should charge battery every three months.



# Appendix A Technical Specifications

## A.1 1kVA (L)/2kVA (L)/3kVA (L)

Index		Model						
		1kVA	1kVA(L)	2kVA	2kVA(L)	3kVA	3kVA(L)	
Input features	Voltage range(V)	When the voltage range is 176Vac~295Vac, it can connect with load that more than 75%; when the voltage range is 154Vac~176Vac, it can connect with load that less than 75%; when the voltage range is 120Vac~154Vac, it can connect with load that less than 50%.						
	Frequency range (Hz)	50/60±10%(50/60 self-adaption)						
	Input method	Single phase three wire						
	Battery voltage (V)	24	36	48	72	72	96	
Output features	Power capacity (VA/W)	1000/900		2000/1800		3000/2700		
	Voltage (V)	220±2%(208/220/230/240 settable)						
	Frequency (Hz)	50/60±0.2%(battery mode)						
	Wave	Sine-wave						
	Voltage distortion	THD < 3%(linear load)						
	Power factor	0.9(If the environment temperature is lower than 30℃, it can set it to 1.0)						
	Transfer time (ms)	0						
	Overload ability	Low overload for 1min	1000VA/900W < Load≤1300VA/1040W		2000VA/1800W < Load≤2600VA/2080W		3000VA/2700W < Load≤3900VA/3120W	
		Medium overload for 1s	1300VA/1040W < Load≤1500VA/1200W		2600VA/2080W < Load≤3000VA/2400W		3900VA/3120W < Load≤4500VA/3600W	
High		Load > 1500VA/1200W		Load > 3000VA/2400W		Load > 4500VA/3600W		

Index		Model		1kVA	1kVA(L)	2kVA	2kVA(L)	3kVA	3kVA(L)	
		overload for 200ms								
Mechanical part	Dimensions (W×D×H)(mm)		145×360×225			190×400×330				
	Weight(kg)		9.2	4.5	17.7	8.5	22.9	9.2		
Other features	Backup time		3 min for full load	According to external battery pack.	3 min for full load	According to external battery pack.	3 min for full load	According to external battery pack.		
	Charge recovery time		For standard model, the charge recovery time is less than 10 hours. For long backup model, the charge recovery time is determined by the capacity of external battery pack.							
	Communication interface		RS232 port supports UPS power management software.							
	Panel display		LCD displays the running status of UPS.							
	Alarm function		Battery low-voltage, mains abnormal, UPS failure, output overload							
	Protection function		Battery under-voltage protection, overload protection, short-circuit protection, over-temperature protection, input over-voltage protection							
	Noise(dB)		<50					<55		
	Working temperature (°C)		-5 ~40							
	Relative humidity		0 ~ 95%, non-condensation							

- Specifications are subject to change without prior notice.

## A.2 6kVA(L)/10kVA(/B) /10kVA(S)

Index		Model	6kVA	6kVA(L)	10kVA(S)	10kVA(/B)		
		Input features		Voltage range(V)	When the voltage range is 176Vac~275Vac, UPS can be with full load. When the voltage range is 80Vac~176Vac, the load capacity decreases linearly according to the input voltage amplitude.			
Frequency range (Hz)	50/60±10%(50/60 self-adaption)							
Input method	Single phase three wire							
Battery voltage (V)	192(default) ( 16~20 cell*12V settable )							
Output features		Power capacity (VA/W)	6000/5400		10000/9000			
		Voltage (V)	220±2%(default)(208/220/230/240 settable)					
		Frequency (Hz)	50/60±0.2%( battery mode)					
		Wave	Sine-wave					
		Voltage distortion	THD<1%(linear load); THD<4%(non-linear load)					
		Power factor	0.9 (If the environment temperature is lower than 30℃, it can set it to 1.0)					
		Transfer time (ms)	0					
		Overload ability	Low overload for 10min (for 1min above 30℃)	6300VA/5670W Load≤7800VA/7020W		<	10500VA/9450W Load≤13000VA/11700W	
			Medium overload for 30s	7800VA/7020W Load≤9000VA/8100W		<	13000VA/11700W Load≤15000VA/13500W	
			High overload for 500ms	Load>9000VA/8100W			Load>15000VA/13500W	

Index		Model			
		6kVA	6kVA(L)	10kVA(S)	10kVA(/B)
Mechanical part	Dimensions(W×D×H) (mm)	230×502×553	190×422×337	230×502×553	190×422×337
	Weight(kg)	54.5	10.9	56.2	12.5
Other features	Backup time	5~20min(full load/ half load)	According to external battery pack.	1~15min(full load/ half load)	According to external battery pack.
	Charge recovery time	For standard model, the charge recovery time is less than 10 hour. For long backup model, the charge recovery time is determined by the capacity of external battery pack.			
	Communication interface	RS232 port supports UPS power management software.			
	Display	LCD displays the running status of UPS.			
	Alarm function	Battery low-voltage, mains abnormal, UPS failure, output overload			
	Protection function	Battery under-voltage protection, overload protection, short-circuit protection, over-temperature protection, input over-voltage protection			
	Noise (dB)	<55			
	Working temperature (°C)	-5 ~ 40			
	Relative humidity	0 ~ 95%, non-condensation			

- Specifications are subject to change without prior notice.

# Appendix B Acronyms and Abbreviations

## A

**AC** Alternating Current

## D

**DC** Direct Current

## E

**ECO** Energy Control Operation

**EPO** Emergency Power Off

## L

**LCD** Liquid Crystal Display

## R

**RS232** Recommend Standard232

## S

**SNMP** Simple Network Management Protocol

## U

**UPS** Uninterruptible Power System

